



## **Industrial Network Unit**

# **INU User Manual Linux**

## **USB Deviceserver INU-100**



## Manufacturer & Contact

SEH Computertechnik GmbH  
Suedring 11  
33647 Bielefeld  
Germany  
Phone: +49 (0)521 94226-29  
Fax: +49 (0)521 94226-99  
Support: +49 (0)521 94226-44  
Email: [info@seh.de](mailto:info@seh.de)  
Web: <https://www.seh-technology.com>



## Document

Type: User Manual  
Title: INU User Manual Linux  
Version: 1.2 | 2021-07

## Legal Information

SEH Computertechnik GmbH has endeavored to ensure that the information in this documentation is correct. If you detect any inaccuracies please inform us at the address indicated above. SEH Computertechnik GmbH will not accept any liability for any error or omission. The information in this manual is subject to change without notification.

The original manual is the German version of this document and shall govern. All non-German versions of this document are translation of the original manual.

All rights are reserved. Copying, other reproduction, or translation without the prior written consent from SEH Computertechnik GmbH is prohibited.

© 2021 SEH Computertechnik GmbH

All trademarks, registered trademarks, logos and product names are property of their respective owners.

# Contents

<b>1</b>	<b>General Information .....</b>	<b>1</b>
1.1	Product .....	2
1.2	Documentation .....	4
1.3	Support and Service.....	5
1.4	Your Safety .....	6
1.5	First Steps .....	7
<b>2</b>	<b>Administration Methods.....</b>	<b>8</b>
2.1	Administration via INU Control Center .....	9
2.2	Administration via the SEH UTN Manager .....	11
2.3	Administration via Email .....	18
<b>3</b>	<b>Network Settings .....</b>	<b>20</b>
3.1	How to Configure IPv4 Parameters .....	21
3.2	How to Configure IPv6 Parameters .....	23
3.3	How to Configure the DNS.....	25
3.4	How to Configure SNMP .....	26
3.5	How to Configure Bonjour .....	27
3.6	How to Configure Email (POP3 and SMTP).....	28
3.7	How to Use the INU Server in VLAN Environments .....	30
<b>4</b>	<b>Device Settings .....</b>	<b>32</b>
4.1	How to Configure the Device Time .....	33
4.2	How to Assign a Description.....	34
4.3	How to Assign a Name to a USB Port.....	35
4.4	How to Disable a USB Port.....	36
4.5	How to Configure the UTN (SSL) Port.....	37
4.6	How to Get Messages.....	38
4.7	How to Use the Relay .....	39
<b>5</b>	<b>Working with the SEH UTN Manager .....</b>	<b>41</b>
5.1	How to Find INU Servers/USB Devices in the Network .....	42
5.2	How to Establish a Connection to a USB Device .....	44
5.3	How to Cut the Connection between the USB Device and the Client .....	45
5.4	How to Request an Occupied USB Device.....	46
5.5	How to Automate USB Device Connections and Program Starts .....	47
5.6	How to Find Status Information on USB Ports and USB Devices.....	49
5.7	How to Use the Selection List and Manage User Access Rights with It.....	50
5.8	How to Use the SEH UTN Manager without Graphical User Interface (utnm).....	52
<b>6</b>	<b>Security.....</b>	<b>56</b>
6.1	How to Encrypt the USB Connection.....	57
6.2	How to Encrypt the Connection to the INU Control Center.....	59
6.3	How to Define the Encryption Strength for SSL/TLS Connections .....	60
6.4	How to Protect Access to the INU Control Center (User Accounts).....	62
6.5	How to Block Ports of the INU Server (TCP Port Access Control).....	63
6.6	How to Control Access to USB Devices.....	64
6.7	How to Block USB Device Types .....	66

- 6.8 How to Use Certificates ..... 67
- 6.9 How to Configure Network Authentication (IEEE 802.1X) ..... 72
- 7 Maintenance ..... 75**
- 7.1 How to Restart the INU Server ..... 76
- 7.2 How to Update ..... 77
- 7.3 How to Backup Your Configuration ..... 78
- 7.4 How to Reset Parameters to their Default Values ..... 80
- 8 Appendix ..... 81**
- 8.1 Troubleshooting ..... 82
- 8.2 Parameter Lists ..... 85
- 8.3 SEH UTN Manager – Feature Overview ..... 105
- 8.4 Index ..... 107

# 1 General Information

- Product ⇨ 2
- Documentation ⇨ 4
- Support and Service ⇨ 5
- Your Safety ⇨ 6
- First Steps ⇨ 7

## 1.1 Product

### Purpose

INU servers integrate non-network-ready USB devices (e.g. USB sensors, USB cameras, etc.) into an industrial environment via TCP/IP network. For this purpose, the USB devices will be connected to the USB ports of the INU server. Then the UTN (UTN = USB to Network) functionality and the corresponding software tool 'SEH UTN Manager' establish a virtual USB connection between USB device and client. The USB device can be used as if it were connected locally.

In addition, a load can be connected to and then used via the relay of the INU server. By default, predefined events and errors switch the relay. For example, an active connection to a USB device can be visualized by a lamp or the loss of a power supply by an acoustic alarm signal. Alternatively, the relay can be switched manually or via SNMP. Thus diverse, individually adapted relay scenarios can be set up in your environment.

### System Requirements

The UTN server has been designed for the use in TCP/IP networks.

The SEH UTN Manager can be used in the following systems:

- Microsoft Windows (32/64-Bit; Windows 10 or higher, Server 2012 R2 or higher)
- macOS 10.9 or higher <sup>1</sup>
- Linux (Debian 10, Ubuntu 20.0.4, Red Hat Enterprise Linux 8, Oracle 8, CentOS 8, SUSE Linux Enterprise 15.1, openSUSE Leap 15.1) <sup>2</sup>
- IPv4 TCP/IP network

The SEH Product Manager can be used under the following systems:

- Microsoft Windows (32/64-Bit; Windows 10 or higher, Server 2012 R2 or higher)
- macOS 10.12.x or higher
- IPv4 TCP/IP network



#### Important:

The support of isochronous USB devices (e.g. cameras, microphones, speakers, etc.) depends on

- the operating system:
  - Windows
  - macOS
  - Linux
- the software version:
  - firmware/software for UTN servers: 14.5.5 or later
  - SEH UTN Manager: 3.1.4 or later

This document describes the usage in Linux environments. Information about the usage in other environments can be found in the relevant system-specific User Manual. More details can be found in chapter 'Documentation' ⇒ 4.

---

1. macOS 11.x (Big Sur) only limited USB device support not running on Apple Silicon (Apple M1 chip) based Macs  
2. A successful installation cannot be guaranteed due to the variety of Linux systems! The installation must be carried out under your own responsibility.

### Combination with Associated Products

You can combine the INU server with additional SEH Computertechnik GmbH products to ideally adapt the use of your devices to your environment!

#### Industrial Solution 'IH-304 USB Hub'

The industrial solution IH-304 is a USB hub with four USB 3.0 ports. If it is connected to the INU server, up to four USB devices can be used per INU server USB port. This is a most efficient solution for control cabinets with little space.

The IH-304 must be purchased separately. Detailed information:

<https://www.seh-technology.com/products/industrial-solutions/ih-304.html>



#### Industrial Solution 'SU-302 Serial to USB Converter'

The industrial solution SU-302 is a serial to USB converter. It can be connected to the INU server via USB and allows for the use of two serial devices via its interfaces RS-232 (for plug type D-Sub, DE-9) and RS-485 (also known as EIA-485; compatible with RS-422/EIA-422).

By combining the INU server and SU-302 you make your serial devices available via network (TCP/IP, Internet)!

<https://www.seh-technology.com/products/industrial-solutions/su-302.html>



#### Industrial Solutions 'Top-Hat Rail Power Supplies'

All Industrial Solutions are mounted on a top-hat rail in a control cabinet. The USB Deviceserver INU-100 and the USB Hub IH-304 are to be connected to a power supply. You either use your existing power supply or—if there is none or no vacancy—you can buy a new one.

Spare yourself the search and use the top-hat rail power supplies DRP-20 and DRP-75 which are specifically selected to perfectly match the industrial solutions!

<https://www.seh-technology.com/products/industrial-solutions/accessories.html>



## 1.2 Documentation



Please load all current documents from our Website:  
<https://www.seh-technology.com>

### Further applicable documents

Thee INU documentation consists of the following documents:

Hardware Installation Guide	Print, PDF	Information on safety, technical data, hardware installation and declarations of conformity
Quick Installation Guide	Print, PDF	Description of initial setup
User Manual	PDF	Detailed description of the INU server configuration, administration and maintenance. System-specific instructions for the following systems: - Windows - macOS - Linux
Online help	HTML	Information on how to use the web interface 'INU Control Center'.  (Embedded into web interface; no download.)
Product information	print, PDF	Features and technical data
Brochures	print, PDF	
Open Source Licenses	online	<a href="https://www.seh-technology.com/services/licenses.html">https://www.seh-technology.com/services/licenses.html</a>

### Symbols and Legend

A variety of symbols and mark-ups are used within this document.



#### WARNING

Warning

A warning contains important information that must be heeded. Non-observance may lead to malfunctions.



#### Important:

Important information

These notes contain crucial information for failure-free operation.

✓ Requirement

Requirements that must be met before you can begin the action.

• Numeration

Listing

1. Numeration

Step-by-step instructions

↳ Result

Outcome of a performed action



Recommendations and beneficial advice



Reference (Within the document you can use hyperlinks.)

**Bold**

Established terms (e.g. of buttons, menu items, or selection lists)

`Courier`

Code (e.g. for command lines or scripts), Paths

'Proper names'

Single quotation marks identify proper names



## 1.3 Support and Service

SEH Computertechnik GmbH offers extensive Support. If you have any questions, please contact us.



Monday through Thursday 8:00 a.m. to 4:45 p.m.  
Friday 8:00 a.m. to 15:15 p.m.



+49 (0)521 94226-44



support@seh.de

Customers from the United States of America (USA) and Canada please contact North American Support:



Monday – Friday 9:00 am – 5:00 pm (EST/EDT)



+1-610-933-2088



support@sehtechnology.com

All information and downloads regarding your product is available on our website:



<https://www.seh-technology.com>



## 1.4 Your Safety

Read and observe all safety regulations and warnings found in the documentation, on the device and on the packaging. This will avoid potential misuse and prevent damages to people and devices.

### Intended Use

The INU server is used in TCP/IP networks and has been designed for use in industrial environments. It allows network users to access non-network-ready USB devices. In addition, a load can be connected to and then used via the relay of the INU server.

### Improper Use

All uses of the device that do not comply with the functionalities described in the INU documentation are regarded as improper uses.

### Safety Regulations

Before starting the initial setup of the INU server, read and observe the safety regulations in the 'Hardware Installation Guide'. This document is enclosed in the packaging in printed form.

### Warnings

Read and observe all warnings mentioned in this document. Warnings are found before any instructions known to be dangerous. They are presented as follows:





### Liability and Guarantee

SEH Computertechnik GmbH will not accept any liability for personal injuries, property damages and consequential damages resulting from the non-observance of the mentioned safety regulations and warnings. Non-observance will also result in any guarantee claims becoming void.

### Modifications to the Device and Repairs

It is not allowed to make modifications to the hardware and software or to try to repair the device. If your device needs to be repaired, contact our support ⇒ 5.

## 1.5 First Steps

1. Read and observe the security regulations in order to avoid damages to people and devices ⇒ 6.
2. Install the hardware. The hardware installation includes connecting the INU server to the network, USB devices, and power grid ⇒  'Hardware Installation Guide'.
3. Install the software. The software installation includes installing the required software tool 'SEH UTN Manager' on your client and assigning an IP address ⇒  'Software Installation Guide'.
4. Configure the INU server so that it is optimally embedded into your network and sufficiently protected. All information on how to do this you will find in this document.
5. Use the SEH UTN Manager to establish and manage connections to the USB devices which are connected to the INU server.



*You can find information on the INU documentation in chapter 'Documentation' ⇒ 4.*

## 2 Administration Methods



You can administer, configure and maintain the INU server in a number of ways:

- Administration via INU Control Center ⇒ 9
- Administration via the SEH UTN Manager ⇒ 11
- Administration via Email ⇒ 18

## 2.1 Administration via INU Control Center

The INU server has a user interface, the INU Control Center which can be opened in an Internet browser (e.g. Mozilla Firefox).

The INU server can be configured, monitored and maintained via the INU Control Center.

- Open INU Control Center in Browser ⇒ 9
- INU Open Control Center via SEH UTN Manager ⇒ 9
- Controls ⇒ 10

### Open INU Control Center in Browser



- ✓ The INU server is connected to the network and the power grid.
  - ✓ The INU server has a valid IP address ⇒ 21.
1. Open your browser.
  2. Enter the IP address of the INU server as the URL.
- ↳ The INU Control Center is displayed in the browser.



#### Important:

If the INU Control Center is not displayed, check if a gateway is configured (⇒ 21) and the proxy settings of your browser.

### INU Open Control Center via SEH UTN Manager

- ✓ The INU server is connected to the network and the power grid.
  - ✓ The INU server has a valid IP address ⇒ 21.
  - ✓ The SEH UTN Manager is installed on the client ⇒ 11.
1. Start the SEH UTN Manager.
  2. In the selection list, select the INU server.
  3. In the menu bar, select **UTN Server–Configure**.
- ↳ Your browser opens and the INU Control Center is displayed.

Controls

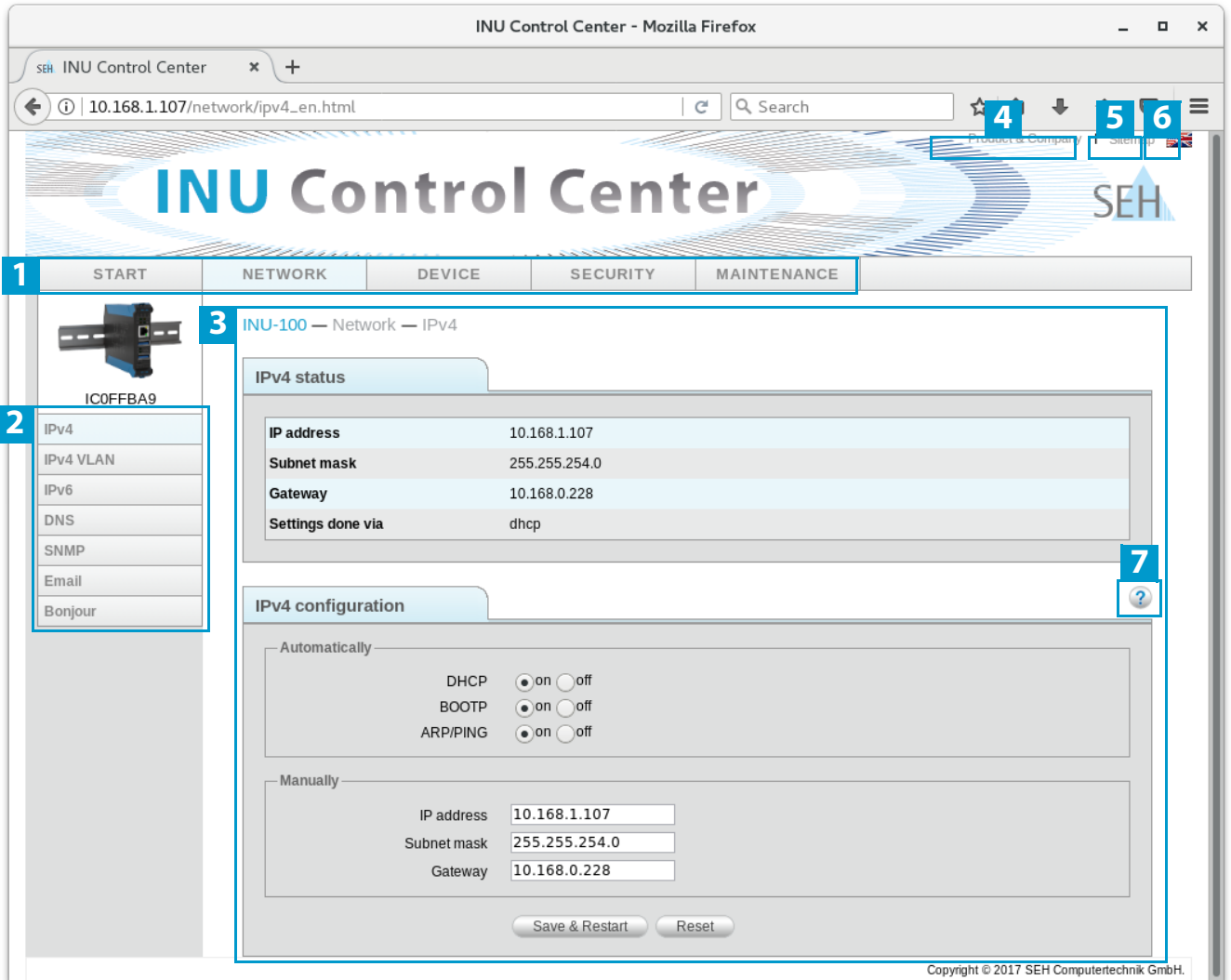

Figure 1: INU Control Center

- |   |                   |  |
|---|-------------------|--|
| 1 | Menu item         | After selecting a menu item (simple mouse click), the available submenu items are displayed to the left. |
| 2 | Submenu items     | After selecting a submenu item, the corresponding page with its content is displayed.                    |
| 3 | Page              | Menu content   |
| 4 | Product & Company | Manufacturer's contact details and additional product information.                                       |
| 5 | Sitemap           | Overview of and direct access to all pages of the INU Control Center.                                    |
| 6 | Flags             | Language selection   |
| 7 | ? icon            | Online help  |

## 2.2 Administration via the SEH UTN Manager

The 'SEH UTN Manager' is a software tool developed by SEH Computertechnik GmbH. The SEH UTN Manager is used to establish and manage connections to the USB devices connected to the INU servers.

- Features ⇒ [11](#)
- Versions ⇒ [13](#)
- Installation ⇒ [13](#)
- Program Start ⇒ [17](#)

### Features

The software is installed on all clients that are meant to access a USB device in the network. After the SEH UTN Manager is started, the network is scanned for connected INU servers. All INU servers found and their connected USB devices are displayed in the 'network list'. To use the USB devices connected to the INU server, you have to add the INU server to the 'selection list'. The devices shown in the selection list can be administrated and the connected USB devices can be used. Working with the SEH UTN Manager is described in detail in the chapter 'Working with the SEH UTN Manager' ⇒ [41](#).



### WARNING

UTN (⇒ [2](#)) and the corresponding SEH UTN Manager only work in IPv4 networks.

In IPv6-only networks only the INU Control Center (⇒ [9](#)) can be accessed to administrate the INU server.



Abbildung 2: SEH UTN Manager

- |   |  |  |
|---|--|--|
| 1 | Menu bar                                 | Available menu items   |
| 2 | Selection List                           | Shows the selected INU servers and the connected USB devices.  |
| 3 | Buttons for editing the selection list   | Opens the dialog for searching INU servers in the network and for selecting the desired devices ⇒ 42.            |
| 4 | Buttons for managing the port connection | Establishes a connection to the USB device connected to the USB port (⇒ 44) or interrupts the connection (⇒ 45). |
| 5 | Display area for the properties          | Shows information on the selected INU server or USB device ⇒ 49.   |

Detailed information on how to use the SEH UTN Manager can be found in the ⇒ 'SEH UTN Manager Online Help'. To start the online help, go to the SEH UTN Manager menu bar and select **Help – Online Help**.

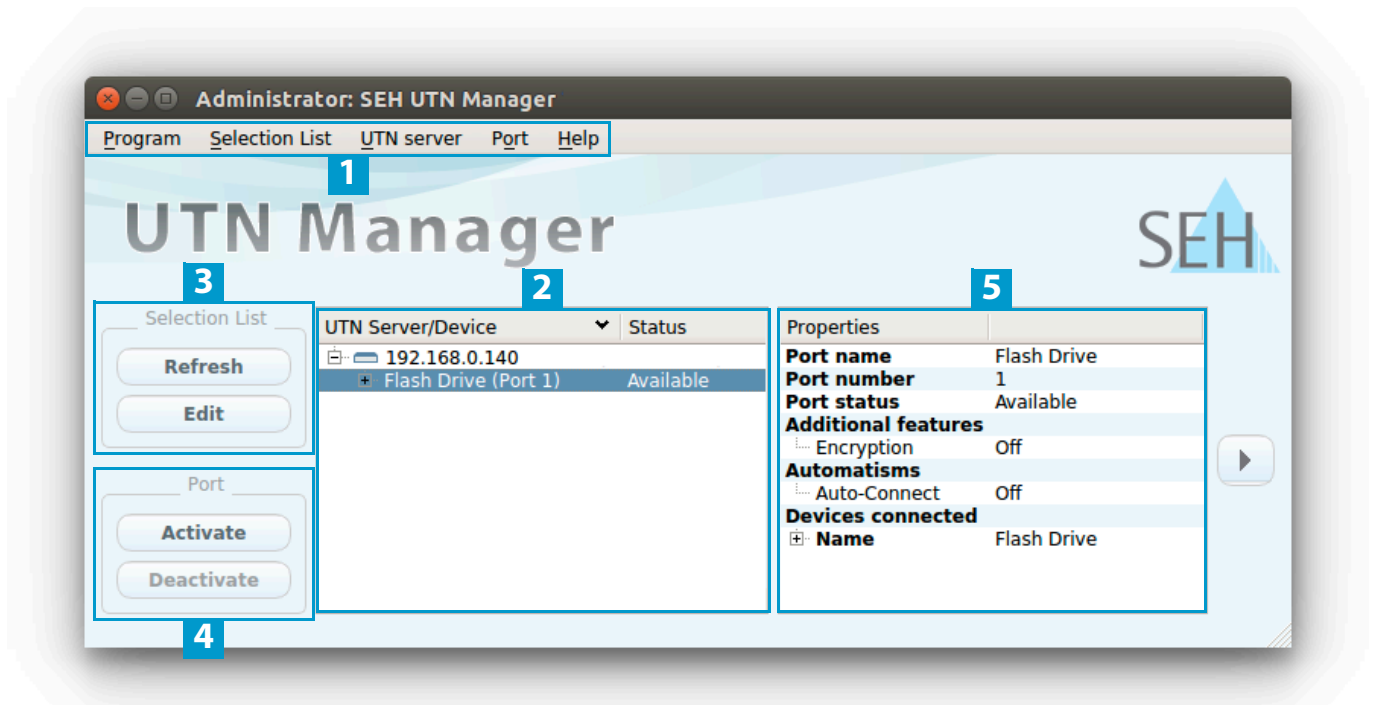

**Important:**

Some SEH UTN Manager features might not be displayed or are displayed as inactive. This depends on

- the type and location of the selection list
- the user's rights and the group memberships on the client
- the client operating system
- the settings of the product-specific security mechanisms
- the status of the INU server and respective USB port

More details can be found in chapter 'SEH UTN Manager – Feature Overview' ⇒ 105.



## Versions

The SEH UTN Manager is available in two versions:

- Complete Version:  
SEH UTN Manager with graphical user interface (⇒ Figure 2 112) and additional features.
- Minimal version (without graphical user interface):  
Usage only via command line ('utnm' ⇒ 152) .



### Important:

The complete version is recommended for general use.  
The minimal version is to be used by experts only!

In both versions the 'SEH UTN Service' (Daemon) works in the background and is automatically active after the system start.

Additionally, the following user groups are distinguished:

- users with administrative rights (administrator)
- users without administrative rights (standard user)



### Important:

Some features can only be configured by administrators. More details can be found in chapter 'SEH UTN Manager – Feature Overview' ⇒ 105.

## Installation

In order to use the SEH UTN Manager, the program must be installed on a computer with a Linux operating system. The SEH UTN Manager installation file can be found on the SEH Computertechnik GmbH website:

<https://www.seh-technology.com/us/services/downloads.html>



The following installation packages are available for Linux systems (64-bit):

- \*.deb (for 64-bit Debian-based systems)
- \*.rpm (for 64 bit Red Hat-based systems)



### WARNING

A successful installation cannot be guaranteed due to the multitude of Linux varieties!

The installation must be carried out on your own.

SEH Computertechnik GmbH provides installation support upon request for a fee  
⇒ 5.

The installation was successfully tested in the following 64-bit systems:

- Debian: Debian10, Ubuntu 20.0.4
- Red Hat: Red Hat Enterprise Linux 8, Oracle 8, CentOS 8, openSUSE Leap 15.1

Installation requirements

- ✓ deb: Linux kernel 2.6.32 or later, glibc 2.15 or later, DKMS (Dynamic Kernel Module Support)
- ✓ rpm: Linux kernel 2.6.32 or later, glibc 2.12 or later, DKMS (Dynamic Kernel Module Support)

There are four installation packages:

- 1) driver
- 2) service (SEH UTN service/daemon)
- 3) clitool (command line interface tool 'utnm')
- 4) manager (graphical user interface)

The number of installed packages determines the version of the SEH UTN Manager:

package 1)-3): minimal version

package 1)–4): complete version

**Important:**

Install the packages in the order given above to comply with their dependencies.

The installation of the files depends on the distribution. For more information, refer to the documentation of your operating system.

**Important:**

Installation must only be carried out by experienced users.

Some installation examples are given below.

- 'Installing the SEH UTN Manager in Ubuntu 16.04.x LTS (64-Bit) via Software Management' ⇒ 15
- 'Installing the SEH UTN Manager in Ubuntu 20.0.4.x LTS (64-Bit) via Terminal' ⇒ 17
- 'Installing the SEH UTN Manager in Ubuntu 20.0.4.x LTS (64-Bit) via Terminal' ⇒ 17

**Important:**

Knowledge Base articles with further installation information for Linux (e.g. installation of DKMS and the UEFI Secure Boot problem) are available at the SEH Computertechnik GmbH website:

<https://www.seh-technology.com/services/knowledgebase.html>



Installing the SEH UTN Manager in Ubuntu 16.04.x LTS (64-Bit) via Software Management

- ✓ Linux kernel 2.6.32 or later
  - ✓ glibc 2.15 or later
  - ✓ OpenSSL 1.0.1 or later
  - ✓ DKMS (Dynamic Kernel Module Support) is installed on the client.
  - ✓ The user used can gain root privileges via the command `sudo`.
1. Start installation package no. 1.  
The **Ubuntu Software** appears.
  2. Click **Install**.  
A password prompt appears.
  3. Authenticate yourself with your password.  
The package will be installed on your client.
  4. Repeat steps 1 through 3 with the remaining packages.
  5. Add all users that are to administrate the SEH UTN Manager on the client to the user group 'utnusers'. To do this, open a **Terminal** and enter the command:  

```
sudo usermod -aG utnusers <user name>
```
  6. Logout and login again so that the group changes take effect.  
↳ The SEH UTN Manager is installed on your client. Check the installation by starting the SEH UTN Manager (⇒ 17) and activating a connection to the USB port including the connected USB device. All information on this can be found in chapter 'Working with the SEH UTN Manager' ⇒ 41.

Installing the SEH UTN Manager in Ubuntu 20.04.x LTS (64-Bit) via Software Management

- ✓ Linux kernel 2.6.32 or later
- ✓ glibc 2.15 or later
- ✓ OpenSSL 1.0.1 or later
- ✓ DKMS (Dynamic Kernel Module Support) is installed on the client.
- ✓ The user used can gain root privileges via the command `sudo`.

1. Open a **Terminal**.

## 2. Install the headers for your kernel:

```
sudo apt-get install linux-headers-`uname -r`
```

## 3. Verify, that the version numbers of kernel and headers match exactly:

Kernel: `uname -r`

Header: `sudo apt list --installed | grep linux-headers`

**WARNING**

The version numbers must be identical. Otherwise, the SEH UTN Manager packages cannot be installed correctly.

If kernel and headers do not match, you must create a match on your own.

## 4. Change to the directory containing the SEH UTN Manager packages:

```
cd <directory>
```

## 5. Install the desired SEH UTN Manager packages:

```
sudo dpkg -i <full package name>
```

6. Add all users that are to administrate the SEH UTN Manager on the client to the user group 'utnusers'. To do this, open a **Terminal** and enter the command:

```
sudo usermod -aG utnusers <user name>
```

## 7. Logout and login again so that the group changes take effect.

- ↳ The SEH UTN Manager is installed on your client. Check the installation by starting the SEH UTN Manager (⇒ 17) and activating a connection to the USB port including the connected USB device. All information on this can be found in chapter 'Working with the SEH UTN Manager' ⇒ 41.

Installing the SEH UTN Manager in Ubuntu 20.04.x LTS (64-Bit) via Terminal

- ✓ Linux kernel 2.6.32 or later
- ✓ glibc 2.15 or later
- ✓ OpenSSL 1.0.1 or later
- ✓ DKMS (Dynamic Kernel Module Support) is installed on the client.
- ✓ The user used can gain root privileges via the command `sudo`.

1. Open a **Terminal**.

## 2. Install the headers for your kernel:

```
sudo yum install kernel-devel-`uname -r`
```

## 3. Verify, that the version numbers of kernel and headers match exactly:

Kernel: `uname -r`

Header: `sudo yum list | grep kernel-headers`

**WARNING**

The version numbers must be identical. Otherwise, the SEH UTN Manager packages cannot be installed.

If kernel and headers do not match, you must create a match on your own.

## 4. Change to the directory containing the SEH UTN Manager packages:

```
cd <directory>
```

## 5. Install the desired SEH UTN Manager packages:

```
sudo yum install <full package name>
```

6. Add all users that are to administrate the SEH UTN Manager on the client to the user group 'utnusers'. To do this, open a **Terminal** and enter the command:

```
sudo usermod -aG utnusers <user name>
```

## 7. Logout and login again so that the group changes take effect.

- ↳ The SEH UTN Manager is installed on your client. Check the installation by starting the SEH UTN Manager (⇒ 17) and activating a connection to the USB port including the connected USB device. All information on this can be found in chapter 'Working with the SEH UTN Manager' ⇒ 41.

**Program Start**

To start the SEH UTN Manager, go to the launcher and call 'UTN Manager' via Dash (search) or go to **Terminal** and run the command `utnmanager`.

**Update**

You can check for program updated manually and automatically. More information can be found in the ⇒ 'SEH UTN Manager Online Help'.

## 2.3 Administration via Email

You can administrate the INU server via email and thus from any computer Internet access (remote access):

- Get INU server status
- Set INU server parameters
- INU server update

To do so, you write commands into the email message header ⇒ Table 1 ¶18.

Table 1: Commands and comment:

Commands	Option	Description
<Command>	get status	You get the INU server status page.
	get parameters	You get the INU server parameter list.
	set parameters	Sends one or more parameters to the INU server which will then be adopted by the INU server. Write the parameters and their values into the email message body: <parameter> = <value>
		The syntax and values can be found in the parameter lists ⇒ ¶85.
	update utn	Carries out an automatic update using the software that is attached to the mail.
	help	You get a page with information on remote maintenance.
[<Comment>]		Freely definable text for descriptions.

The following applies to the instructions:

- not case-sensitive
- one or more space characters are allowed
- max. length is 128 byte
- only the ASCII format can be read.

In addition, a TAN is needed to execute updates or parameter changes. To begin with, you have to get a status page via email (⇒ Table 1 ¶18) because it contains the TAN. You enter the received TAN into the email message body. A space character must follow.

- ✓ A DNS server is configured on the INU server ⇒ ¶25.
- ✓ In order to receive emails, the INU server must be set up as user with its own email address on a POP3 server.
- ✓ POP3 and SMTP parameters have been configured on the INU server ⇒ ¶28.

1. Open an email program.
  2. Write a new email:
    - As recipient enter the INU server address.
    - Into the subject line enter an instruction. cmd: <command> [<comment>]  
Commands and comment: ⇒ Table 1 ¶18.
    - Into the email message body enter a TAN, if applicable.
  3. Send the email.
- ↳ The INU server receives the email and carries out the instruction.

**Examples**

You want to get the INU server parameter list:

To: INUserver@company.com

Subject: cmd: get parameters

You want to set the 'configuration' parameter:

To: INUserver@company.com

Subject: cmd: set parameters

Email message body: TAN = nUn47ir79Ajs7QKE  
sys\_descr = <Your description>

## 3 Network Settings

To optimally embed your INU server into your network, you can configure the following settings:

- [How to Configure IPv4 Parameters](#) ⇨ 21
- [How to Configure IPv6 Parameters](#) ⇨ 23
- [How to Configure the DNS](#) ⇨ 25
- [How to Configure SNMP](#) ⇨ 26
- [How to Configure Bonjour](#) ⇨ 27
- [How to Configure Email \(POP3 and SMTP\)](#) ⇨ 28
- [How to Use the INU Server in VLAN Environments](#) ⇨ 30





## 3.1 How to Configure IPv4 Parameters

In the hardware installation (⇒  'Hardware Installation Guide') the INU server is connected to the network. The INU server then checks if it gets IP address dynamically via the boot protocols BOOTP (Bootstrap Protocol) or DHCP (Dynamic Host Configuration Protocol). If this is not the case, the INU server assigns itself an IP address via Zeroconf from the address range which is reserved for Zeroconf (169.254.0.0/16).





### Important:

If the INU server is connected to an IPv6 network, it will automatically receive an additional IPv6 address ⇒ .

The IPv4 address assigned to the INU server can be found via the software tool 'SEH UTN Manager'. This step usually is carried out during the initial set up (⇒  'Quick Installation Guide').

To optimally embed the INU server into a TCP/IP network, you can configure different IPv4 parameters and/or manually assign a static IP address to it.

- Configuring IPv4 Parameters via the INU Control Center ⇒  21
- Configuring IPv4 Parameters via SEH UTN Manager ⇒  22
- Determining the IPv4 Address via SEH UTN Manager and Configuring IPv4 Parameters ⇒  22

### Configuring IPv4 Parameters via the INU Control Center



1. Start the INU Control Center.
2. Select **NETWORK – IPv4**.
3. Configure the IPv4 parameters; ⇒ Table 2 .
4. Click **Save & Restart** to confirm.  
↳ The settings will be saved.

Table 2: IPv4 parameters

Parameters	Description
DHCP BOOTP ARP/PING	<p>Enables or disables the protocols DHCP, BOOTP, and ARP/PING.</p> <p>The IP address assignment via DHCP and BOOTP is automatic if one of these protocols is implemented in your network.</p> <p>You can use the commands ARP and PING to change an IP address which was assigned via Zeroconf. The implementation depends on your system; read the documentation of your operating system.</p> <p> <i>We recommend disabling these options once an IP address has been assigned to the INU server.</i></p>
IP address	IP address of the INU server.
Subnet mask	<p>Subnet mask of the INU server.</p> <p>Subnet masks are used to logically partition big networks into subnetworks. If you are using the INU server in a subnetwork, it requires the subnet mask of the subnetwork.</p>
Gateway	<p>IP address of the network's standard gateway which the INU server uses.</p> <p>With a gateway, you can address IP addresses from other networks.</p>

### Configuring IPv4 Parameters via SEH UTN Manager

- ✓ The SEH UTN Manager (complete version) is installed on the client ⇒ 111.
  - ✓ The INU server is shown in the selection list ⇒ 42.
1. Start the SEH UTN Manager.
  2. In the selection list, select the INU server.
  3. In the menu bar, select **UTN Server–Set IP Address**.  
The **Set IP Address** dialog appears.
  4. Enter the relevant TCP/IP parameters.
  5. Click **OK**.
- ↳ The settings will be saved.

### Determining the IPv4 Address via SEH UTN Manager and Configuring IPv4 Parameters

The SEH UTN Manager searches the network for connected INU servers.

- ✓ The SEH UTN Manager (complete version) is installed on the client ⇒ 111.
1. Start the SEH UTN Manager.
  2. Confirm the note dialog **Your Selection List seems to be empty** with **Yes**.  
If no note dialog is available and the main dialog appears, select **Selection List–Edit** in the menu bar.  
The **Edit Selection List** dialog appears.
  3. In the network list, select the INU server.



*If you are using several INU servers, you can identify a specific device by its default name (⇒ 81) or the connected USB devices.*

4. In the shortcut menu, select **Set IP Address**.  
The **Set IP Address** dialog appears.
  5. Enter the relevant TCP/IP parameters.
  6. Click **OK**.
- ↳ The settings will be saved.

## 3.2 How to Configure IPv6 Parameters

IPv6 (Internet Protocol Version 6) is the successor of the still predominantly used IPv4 (Internet Protocol Version 4). IPv6 offers the same basic functions but has many advantages such as the increased address space of  $2^{128}$  (IPv6) instead of  $2^{32}$  (IPv4) IP addresses and auto configuration.



### Important:

IPv6 address notation differs from IPv4: An IPv6 address consists of 128 bits. The normal format of an IPv6 address is eight fields. Each field contains four hexadecimal digits representing 16 bits.

Example: `2001:db8:4:0:2c0:ebff:fe0f:3b6b`

As a URL in a Web browser, an IPv6 address must be enclosed in square brackets. This prevents port numbers from being mistakenly regarded as part of an IPv6 address.

Example: `http://[2001:db8:4:0:2c0:ebff:fe0f:3b6b]:443`

The URL will only be accepted by browsers that support IPv6.

You can embed the INU server into an IPv6 network.



### WARNING

UTN (⇒ 2) and the corresponding SEH UTN Manager only work in IPv4 networks. The SEH Product Manager also only works in IPv4 networks.

In IPv6-only networks only the INU Control Center (⇒ 9) can be accessed to administrate the INU server.

The INU server will automatically receive one or more IPv6 addresses in addition to its IPv4 address. To optimally embed the INU into your network, you can configure IPv6 parameters.

1. Start the INU Control Center.
2. Select **NETWORK – IPv6**.
3. Configure the IPv6 parameters; ⇒ Table 3 24.
4. Click **Save & Restart** to confirm.  
↳ The settings will be saved.

Table 3: IPv6 parameters

Parameters	Description
IPv6	Enables/disables the IPv6 functionality of the INU server.
Automatic configuration	Enables/disables the automatic assignment of the IPv6 address to the INU server.
IPv6 address	<p>Defines an IPv6 unicast address in the format n:n:n:n:n:n:n which is manually assigned to the INU server.</p> <ul style="list-style-type: none"><li>• Every 'n' represents the hexadecimal value of one of the eight 16 bit elements of the address.</li><li>• Leading zeros can be omitted.</li><li>• An IPv6 address may be entered or displayed using a shortened version when successive fields contain all zeros (0). In this case, two colons (::) are used.</li></ul>
Router	Manually defines a static router to which the INU server sends its requests.
Prefix length	<p>Defines the length of the subnet prefix for the IPv6 address. The value 64 is pre-set.</p> <p>Address ranges (e.g. your network) are specified with prefixes. To do this, the prefix length (number of bits used) is added to the IPv6 address as a decimal number and the decimal number is preceded by '/'.</p>

### 3.3 How to Configure the DNS

DNS is a service to translate domain names into IP addresses and vice versa. Enable DNS so that you can enter host names instead of IP addresses when you define servers.

Example: Time server configuration (⇒ [33](#)) with `ntp.server.de` instead of `10.168.0.140`.



#### Important:

If your network is configured accordingly, the INU server receives the DNS settings automatically via DHCP. A DNS server assigned in such a manner always takes precedence over manual settings.

- ✓ Your network has a DNS server.
- 1. Start the INU Control Center.
- 2. Select **NETWORK – DNS**.
- 3. Configure the DNS parameters; ⇒ [Table 4](#) [25](#).
- 4. To confirm, click **Save**.

Table 4: The settings will be saved. DNS parameters

Parameters	Description
DNS	Enables/disables the name resolution via a DNS server.
Primary DNS server	Defines the IP address of the primary DNS server.
Secondary DNS server	Defines the IP address of the secondary DNS server. The secondary DNS server is used if the first one is not available.
Domain name (suffix)	Defines the domain name of an existing DNS server.

### 3.4 How to Configure SNMP

SNMP (Simple Network Management Protocol) is protocol for configuring and monitoring network elements. The protocol controls communication between the monitored devices and the monitoring station (SNMP management tool). Information can be read and changed.

SNMP exists in 3 versions, the INU supports version 1 and 2.

#### SNMPv1

SNMPv1 is the first and most simple SNMP version. A disadvantage is the insecure access control which is the community: a community groups monitoring station and monitored devices. This makes their administration easier. There are two types of communities, read-only and read/write. For both the community name is also the password used between the monitoring station and the monitored devices. As it is transmitted as clear text, it does not offer sufficient protection.

#### SNMPv3

SNMPv3 is the newest SNMP version. It contains enhancements and a new security concept which includes, amongst other things, encryption and authentication. Therefore, a SNMP user with name and password must be created in the monitoring station. This user must then be specified in the INU server.



**Important:**

The user accounts are also used to access the INU Control Center and thus are to be defined under **SECURITY - Device access** 'How to Protect Access to the INU Control Center (User Accounts)' ⇒ 62.

- ✓ SNMPv3 users are created in the monitoring station. (Only for SNMPv3.)
  - ✓ The SNMPv3 users from the monitoring station are specified on the INU server ⇒ 62. (Only for SNMPv3.)
1. Start the INU Control Center.
  2. Select **NETWORK – SNMP**.
  3. Configure the SNMP parameters; ⇒ Table 5 26.
  4. To confirm, click **Save**.

Table 5: The settings will be saved.SNMP Parameters

Parameters	Description
SNMPv1	Enables/disables SNMPv1.
Read-only	Enables/disables the write protection for the community.
Community	SNMP community name Enter the name as it is defined in the monitoring station.
	<p><b>Important:</b> The default name is 'public'. This name is commonly used for read/write communities. We recommend to change it as soon as possible to increase security.</p>
SNMPv3	Enables/disables SNMPv3.
Hash	Defines the hash algorithm.
Access rights	Defines the access rights of the SNMP user.
Encryption	Defines the encryption method.

## 3.5 How to Configure Bonjour

Bonjour is a technology which automatically detects devices and services in TCP/IP networks.

The INU server uses Bonjour to

- verify IP addresses
  - announce and find network services
  - match host names and IP addresses
1. Start the INU Control Center.
  2. Select **NETWORK – Bonjour**.
  3. Configure the Bonjour parameters; ⇨ Table 6 27.
  4. To confirm, click **Save**.  
↳ The settings will be saved.

Table 6: Bonjour parameters

Parameters	Description
Bonjour	Enables/disables Bonjour.
Bonjour name	Defines the Bonjour name of the INU server. The INU server uses this name to announce its Bonjour services. If no Bonjour name is entered, a default name will be used (device name@ICxxxxxx).

## 3.6 How to Configure Email (POP3 and SMTP)

The INU server can be administered via email (⇒ 18) and offers a notification service (⇒ 38) which sends you status and error messages via email. To use these features, the email protocols 'POP3' and 'SMTP' must be set up on the INU server.

A client, e.g. the INU server, uses POP3 (Post Office Protocol Version 3) to fetch emails from a mail server. POP3 must be set up on the INU server so that it can be administered via email.

SMTP (Simple Mail Transfer Protocol) is used to send and forward emails. The INU server needs SMTP for the administration via email and the notification service.

- Configuring POP3 ⇒ 28
- Configuring SMTP ⇒ 29

### Configuring POP3

✓ An email user account for the INU server is set up on the POP3 server.

1. Start the INU Control Center.
2. Select **NETWORK – Email**.
3. Configure the POP3 parameters; ⇒ Table 7 28.
4. To confirm, click **Save**.  
↳ The settings will be saved.

Table 7: POP3 parameters

Parameters	Description
POP3	Enables/disables the POP3 functionality.
POP3 – Server name	Defines the POP3 server via its IP address or host name. A host name can only be used if a DNS server was configured beforehand.
POP3 – Server port	Defines the port which the INU server uses to receive emails. The default port number for POP3 is 110. The default port number for SSL/TLS (parameter 'POP3 – Security' ⇒ 28) is 995. If required, read the documentation of your POP3 server.
POP3 – Security	Defines the authentication method to be used: <ul style="list-style-type: none"> <li>• APOP: encrypts the password when logging on to the POP3 server.</li> <li>• SSL/TLS: encrypts the entire communication with the POP3 server. The encryption strength is defined via the encryption protocol and level ⇒ 60.</li> </ul>
POP3 – Check mail every	Defines the time interval (in minutes) which with the POP3 server is checked for emails.
POP3 – Ignore mail exceeding	Defines the maximum email size (in Kbyte) to be accepted by the INU server. (0 = unlimited)
POP3 – User name	Defines the user name used by the INU server to log on to the POP3 server.
POP3 – Password	Defines the user password used by the INU server to log on to the POP3 server.



### Configuring SMTP

- ✓ An email user account for the INU server is set up on the SMTP server.
- 1. Start the INU Control Center.
- 2. Select **NETWORK – Email**.
- 3. Configure the SMTP parameters; ⇨ Table 8 ¶29.
- 4. To confirm, click **Save**.
  - ↳ The settings will be saved.

Table 8: SMTP Parameters

Parameters	Description
SMTP - Server name	Defines the SMTP server via the IP address or the host name. A host name can only be used if a DNS server was configured beforehand.
SMTP – Server port	Defines the port which the INU server and SMTP server use to communicate. The default port number for SMTP is 25. For SSL/TLS (parameter 'SMTP – SSL/TLS' ⇨ ¶29), SMTP servers use by default port 587 (STARTSSL/STARTTLS) or the old port 465 (SMTPS). If required, read the documentation of your SMTP server.
SMTP – SSL/TLS	Enables/disables SSL/TLS. SSL/TLS encrypts the communication from the INU to the SMTP server. The encryption strength is defined via the encryption protocol and level ⇨ ¶60.
SMTP – Sender name	Defines the email address used by the INU server to send emails. Very often the name of the sender and the email account user name are identical.
SMTP – Login	Enables/disables SMTP authentication. To send emails, the INU sends its user name and password to the SMTP server to authenticate itself. Enter user name (parameter 'SMTP – User name' ⇨ ¶29) and password (parameter 'SMTP – Password' ⇨ ¶29). Some SMTP servers require SMTP authentication to prevent fraudulent use (spam).
SMTP – User name	Defines the user name used by the INU server to log on to the SMTP server.
SMTP – Password	Defines the password used by the INU server to log on to the SMTP server.
SMTP – Security (S/MIME)	Enables/disables the email security standard S/MIME (Secure/Multipurpose Internet Mail Extensions). S/MIME is used to sign ('SMTP – Signing emails' ⇨ ¶29) or encrypt ('SMTP – Full encryption' ⇨ ¶29) emails. Enable the desired features (if desired with 'SMTP – Attach public key' ⇨ ¶29).
SMTP – Signing emails	Enables the signing of emails. The recipient can use the signature to check the sender's identity. This proves, that the email has not been altered. An S/MIME certificate is required for the signing of emails ⇨ ¶67.
SMTP – Full encryption	Enables the encryption of emails. Only the intended recipient can open and read the encrypted email. An S/MIME certificate is required for the encryption ⇨ ¶67.
SMTP – Attach public key	Sends the public key together with the email. Many email clients require the key to display the email.

## 3.7 How to Use the INU Server in VLAN Environments

The INU server supports VLAN (Virtual Local Area Network) according to 802.1Q.

A VLAN divides a physical network into logical subnetworks. Each subnetwork is its own broadcast domain, so data packets cannot be exchanged between subnetworks. VLANs are used to structure networks and, above all, to secure them.

Each USB device can be assigned to a VLAN. To transfer VLAN data via the USB ports, you must first enter the VLANs on the INU server. After this, the USB ports used for forwarding data must be linked to the specified VLANs.



*The access to USB devices can be regulated particularly well with VLAN: a defined group of network users may use certain USB devices.  
Inform yourself on how to implement VLAN in your environment and then set up the INU server for it.*

- Define a IPv4 Management VLAN ⇒ 30
- Define a IPv4 Client VLAN ⇒ 30
- Allocating a IPv4 Client VLAN to a USB Port ⇒ 31

### Define a IPv4 Management VLAN

1. Start the INU Control Center.
2. Select **NETWORK – IPv4 VLAN**.
3. Configure the IPv4 VLAN parameters; ⇒ Table 9 30.
4. To confirm, click **Save**.
5. The settings will be saved.

Table 9: IPv4 management VLAN parameters

Parameters	Description
IPv4 management VLAN	Enables/disables the forwarding of IPv4 management VLAN data. If this option is enabled, SNMP is only available in the IPv4 management VLAN.
VLAN ID	ID for the identification of the IPv4 management VLAN (0–4096).
IP address	IP address of the INU server ⇒ 21.
Subnet mask	Subnet mask of the INU server ⇒ 21.
Gateway	IP address of the network's standard gateway which the INU server uses ⇒ 21. With a gateway, you can address IP addresses from other networks.
Access from any VLAN	Enables/disables the administrative access (web) to the INU server via IPv4 client VLANs. If this option is enabled, the INU server can be administrated via all VLANs.
Access via LAN (untagged)	Enables/disables the administrative access to the INU server via IPv4 packets without tag. If this option is disabled, the INU server can only be administrated via VLANs.

### Define a IPv4 Client VLAN

1. Start the INU Control Center.
  2. Select **NETWORK – IPv4 VLAN**.
  3. Configure the IPv4 VLAN parameters; ⇒ Table 10 31.
  4. To confirm, click **Save**.
- ↳ The settings will be saved.

Table 10: IPv4 client VLAN parameters

Parameters	Description
VLAN	Enables/disables the forwarding of IPv4 client VLAN data.
IP address	IP address of the INU server within the IPv4 client VLAN.
Subnet mask	Subnet mask of the INU server within the IPv4 client VLAN.
Gateway	Gateway address of the IPv4 client VLAN.
VLAN ID	ID for the identification of the IPv4 client VLAN (0–4096).



Use **Auto-fill** to automatically fill **VLAN**, **IP address** and **Subnetmask** with the values from line 1. **VLAN ID** will automatically be counted up by '1'.

### Allocating a IPv4 Client VLAN to a USB Port

1. Start the INU Control Center.
2. Select **SECURITY – USB port access**.
3. Allocate a VLAN to the USB port via the **Allocate VLAN** list.
4. To confirm, click **Save**.
  - ↳ The settings will be saved.

## 4 Device Settings

- How to Configure the Device Time ⇨ 33
- How to Assign a Description ⇨ 34
- How to Assign a Name to a USB Port ⇨ 35
- How to Disable a USB Port ⇨ 36
- How to Configure the UTN (SSL) Port ⇨ 37
- How to Get Messages ⇨ 38
- How to Use the Relay ⇨ 39

## 4.1 How to Configure the Device Time

The device time of the INU server can be set via an SNTP time server (Simple Network Time Protocol) in the network. A time server synchronizes the time of devices within a network.

Today's primary time standard 'UTC' (Universal Time Coordinated) is used. The time zone compensates for location.



### Important:

If your network is configured accordingly, the INU server receives the time server settings automatically via DHCP. A time server assigned in such a manner always takes precedence over a manually set time server.

- ✓ The network has a time server.
- 1. Start the INU Control Center.
- 2. Select **DEVICE – Date/Time**.
- 3. Tick **Date/Time**.
- 4. Into the **Time server** box, enter the IP address or the host name of the time server.  
(The host name can only be used if a DNS server was configured beforehand ⇒ 25.)
- 5. From the **Time zone** list, select the code for your local time zone.
- 6. To confirm, click **Save**.
  - ↳ The settings will be saved.

## 4.2 How to Assign a Description

You can assign freely definable descriptions to the INU server. This gives you a better overview of the devices in the network.



*You can also assign names to USB ports to distinguish them ⇔ 35.*

1. Start the INU Control Center.
2. Select **DEVICE – Description**.
3. Enter freely definable names for **Host name**, **Description**, and **Contact person**.
4. To confirm, click **Save**.
  - ↳ The settings will be saved.

Table 11: Description

Parameters	Description
Host name	Device name as alternative to IP address. With a name you can identify the INU server more easily in the network, e.g. if you are using several INU servers. Is displayed in the INU Control Center and SEH UTN Manager.
Description	Device description, e.g. location or department. Is displayed in the INU Control Center and SEH UTN Manager.
Contact person	Contact person, e.g. device administrator. Is displayed in the INU Control Center.

### 4.3 How to Assign a Name to a USB Port

By default, the names of the connected USB devices are displayed on the USB ports in the INU Control Center and SEH UTN Manager. These names are specified by the device manufacturers and might be ambiguous or inaccurate.

That is why you can assign freely definable names to the USB ports, e.g. the name of a corresponding software. This gives you a better overview of the USB devices available in the network.

1. Start the INU Control Center.
2. Select **Device – USB port**.
3. Enter the preferred name into the **Port name** field.
4. To confirm, click **Save**.
  - ↳ The settings will be saved.

## 4.4 How to Disable a USB Port

By default all USB ports are active. You can deactivate (and re-activate ) the USB port by interrupting respectively re-establishing the power supply.

Deactivate

- unused USB ports to ensure that unwanted USB devices cannot be connected to the network. (Deactivated USB ports cannot be seen in the SEH UTN Manager.)
  - a USB port and re-activate it to restart the connected USB device if it is in an undefinable condition. (The USB device does not need to be removed and reconnected manually.)
1. Start the INU Control Center.
  2. Select **Device – USB port**.
  3. Tick/clear the option in front of the **USB port**.
  4. To confirm, click **Save**.
- ↳ The USB port is disabled/enabled.



## 4.5 How to Configure the UTN (SSL) Port

A shared port is used for the data transfer between the INU server (including connected USB devices) and the client. It depends on the connection type:

- unencrypted USB connection: UTN port (default = 9200)
- encrypted USB connection (⇒ ⓘ57): UTN SSL port (default = 9443)



### WARNING

The UTN port respectively UTN SSL port must not be blocked by security measures (firewall).

You can change the port number, e.g. if the port number is already used for another application in your network. The change is made on the INU server and is relayed to the SEH UTN Manager installed on the clients via SNMPv1.

- ✓ SNMPv1 is enabled ⇒ ⓘ26.
1. Start the INU Control Center.
  2. Select **Device – UTN port**.
  3. Enter the port number into the **UTN port** or **UTN SSL port** box.
  4. To confirm, click **Save**.
- ↳ The settings will be saved.

## 4.6 How to Get Messages

The INU server can send you different messages:

- Status email: Periodically sent email containing the status of the INU server and of the connected USB devices.
- Event notifications via email or SNMP trap:
  - USB device is connected to the INUserver / disconnected from the INU server
  - USB port (i.e. connection to the connected USB device) is activated/deactivated
  - INU server restart
- Configuring the sending of status emails ⇒ 38
- Configuring event notifications via email ⇒ 38
- Configuring event notifications via SNMP traps ⇒ 38

### Configuring the sending of status emails

The status email can be sent to up to two recipients.

- ✓ SMTP is set up ⇒ 28.
  - ✓ DNS is set up ⇒ 25.
1. Start the INU Control Center.
  2. Select **DEVICE – Notification**.
  3. Enter the recipient into the **Email address** box.
  4. Tick the desired recipient(s) in the **Status email** area.
  5. Define the interval.
  6. To confirm, click **Save**.
- ↳ The settings will be saved.

### Configuring event notifications via email

The event emails can be sent to up to two recipients.

- ✓ SMTP is set up ⇒ 28.
  - ✓ DNS is set up ⇒ 25.
1. Start the INU Control Center.
  2. Select **DEVICE – Notification**.
  3. Enter the recipient into the **Email address** box.
  4. Tick the options with the desired message types.
  5. To confirm, click **Save**.
- ↳ The settings will be saved.

### Configuring event notifications via SNMP traps

The event SNMP traps can be sent to up to two recipients.

- ✓ SNMPv1 or/and SNMPv3 is set up ⇒ 26.
1. Start the INU Control Center.
  2. Select **DEVICE – Notification**.
  3. In the **SNMP traps** area, define the recipients via the IP address and the community.
  4. Tick the options with the desired message types.
  5. To confirm, click **Save**.
- ↳ The settings will be saved.

## 4.7 How to Use the Relay

A device can be connected to the Change Over (CO) relay which is integrated into the INU server. The relay can

- be fixed in a position of your choice:  
You switch the relay to the desired position (open or closed). The relay stays in the selected position until you switch it manually again.
- display a status:  
By default, the relay is in open position. As soon as one chosen device status occurs, the relay switches to closed position. As soon as the status changes back, the relay automatically returns to open position.
  - USB device connected (any or on a certain port)
  - USB device disconnected (any or on a certain port)
  - USB device activated (any or on a certain port)
  - USB device deactivated (any or a certain port)
  - interrupted network connection
  - network connection established
- show events:  
The relay switches to closed position as soon as one of the chosen events occurs. After that, the relay will not switch automatically anymore; you first have to manually clear the event / reset the relay.
  - USB device connected (any or on a certain port)
  - USB device disconnected (any or on a certain port)
  - USB device activated (any or on a certain port)
  - USB device deactivated (any or a certain port)
  - SD card connected
  - SD card disconnected
  - SC card cannot be used
  - interrupted network connection
  - network connection established
  - INU server restart
  - interrupted power supply
  - power supply established



*The relay can also be switched with a SNMP management tool and the SEH private MIB (download at the website ⇒ 4.4). Switching via SNMP is not described here and must be implemented self-dependently.*

The relay position and events respectively status which changed it, are displayed in the INU Control Center: go to **Device – Relay** and the table **Relay status**.

### Use case examples

*Fixed position:* This is a simple way to switch the relay and therefore the connected device through remote access (HTTP).

Example: The INU server is installed in a production environment. The relay is switched as required by a technician in the control center. Scenarios include a simple connection/disconnection (e.g. diagnosis tool) or an emergency shutdown (e.g. if a sensor warns about overheating).

*Displaying a status:* The status display is especially useful in production environments.

Example: The quality is checked regularly in a manufacturing process. To do this, a USB analysis device is connected to the INU server and automatically activated via Auto-Connect (⇒ 4.7). The activation triggers the relay and a connected light bulb switches on to signal the ongoing check. The employees in the manufacturing environment know about it. As soon as the check is completed and the data transferred over the network to the client with the analysis software, the connection to the USB device is deactivated and it is removed from the INU server. The relay switches and the light bulb goes out. The employees know that the quality check is completed.

*Showing events:* The event display is most suitable for error warnings as a manual reset of the relay is required.

Example: An interrupted network connection is indicated visually through a red lamp or acoustically with an audio alert. As the reset is to be done manually, the error is displayed permanently by the changed relay position. That still is the case even if the error is removed (maybe of its own volition), e.g. if the network connection is re-established after a sever error. This error history can give you valuable information on basic problems in your en-

vironment. As soon as the technician has analyzed and removed the error, the relay is returned to its default position so that the next error (e.g. an interrupted power supply) is indicated as well.

- Fix the Relay in a Position (Respectively Switch It Manually) ⇨ 40
- Have the Relay Show a Status ⇨ 40
- Have the Relay Show an Event ⇨ 40
- Set Relay to Default Position ⇨ 40

### Fix the Relay in a Position (Respectively Switch It Manually)

1. Start the INU Control Center.
  2. Select **DEVICE – Relay**.
  3. Tick **Fixed position**.
  4. From the list, select **Open** or **Closed**.
  5. To confirm, click **Save**.
- ↳ The relay stays in the selected position.

### Have the Relay Show a Status

1. Start the INU Control Center.
  2. Select **DEVICE – Relay**.
  3. Tick **Show status**.
  4. From the lists, select a desired status.  
Only one status can be selected.
  5. To confirm, click **Save**.
- ↳ The settings will be saved.

### Have the Relay Show an Event

1. Start the INU Control Center.
  2. Select **DEVICE – Relay**.
  3. Tick **Show event**.
  4. From the list, select the desired events.  
Multiple selection is possible.
  5. To confirm, click **Save**.
- ↳ The settings will be saved.

### Set Relay to Default Position

- ✓ 'Show event' is activated ⇨ 40.
1. Start the INU Control Center.
  2. Select **DEVICE – Relay**.
  3. In the table **Relay status**, click **Clear all events / reset relay**.
- ↳ The relay is reset.

## 5 Working with the SEH UTN Manager

The 'SEH UTN Manager' is a software tool developed by SEH Computertechnik GmbH. The SEH UTN Manager is used to establish and manage connections to the USB devices which are connected to the INU servers.

- How to Find INU Servers/USB Devices in the Network ⇒ 42
- How to Establish a Connection to a USB Device ⇒ 44
- How to Cut the Connection between the USB Device and the Client ⇒ 45
- How to Request an Occupied USB Device ⇒ 46
- How to Automate USB Device Connections and Program Starts ⇒ 47
- How to Find Status Information on USB Ports and USB Devices ⇒ 49
- How to Use the Selection List and Manage User Access Rights with It ⇒ 50
- How to Use the SEH UTN Manager without Graphical User Interface (utnm) ⇒ 52

## 5.1 How to Find INU Servers/USB Devices in the Network

The software tool SEH UTN Manager is used to establish and manage connections to the USB devices connected to the INU servers.

After the SEH UTN Manager is started, the network has to be scanned for connected INU servers. The network range to be scanned is freely definable; the search can be effected via multicast and/or in definable IP ranges. The default setting is multicast search in the local network segment.

All INU servers found and their connected USB devices are displayed in the 'network list'. To use the USB devices connected to the INU server, you have to add the INU server to the 'selection list'.

You can also directly add an INU server to the selection list. To do this, you need to know its IP address.

- Defining Search Parameters ⇨ 42
- Scanning the Network ⇨ 42
- Adding the INU Server to the Selection List ⇨ 42
- Adding a INU Server via IP Address ⇨ 43

### Defining Search Parameters

✓ The SEH UTN Manager (complete version) is installed on the client ⇨ 11.

1. Start the SEH UTN Manager.
2. In the menu bar, select **Program–Options**.  
The **Options** dialog appears.
3. Select the **Network Scan** tab.
4. Tick **IP Range Search** and define one or more network ranges.
5. Click **OK**.  
↳ The settings will be saved.

### Scanning the Network

✓ The SEH UTN Manager (complete version) is installed on the client ⇨ 11.

1. Start the SEH UTN Manager.
2. In the menu bar, select **Selection List – Edit**.  
The **Edit Selection List** dialog appears.
3. Click **Scan**.
4. The network is scanned. The INU servers and USB devices found are displayed in the network list.

### Adding the INU Server to the Selection List

✓ The SEH UTN Manager (complete version) is installed on the client ⇨ 11.

✓ The INU server was found via the network scan and is displayed in the network list.

1. Start the SEH UTN Manager.
2. In the menu bar, select **Selection List – Edit**.  
The **Edit Selection List** dialog appears.
3. In the network list, select the INU server to be used.
4. Click **Add**.  
(Repeat steps 2 and 3, if necessary.)
5. Click **OK**.  
↳ The INU servers and the connected USB devices are shown in the selection list.

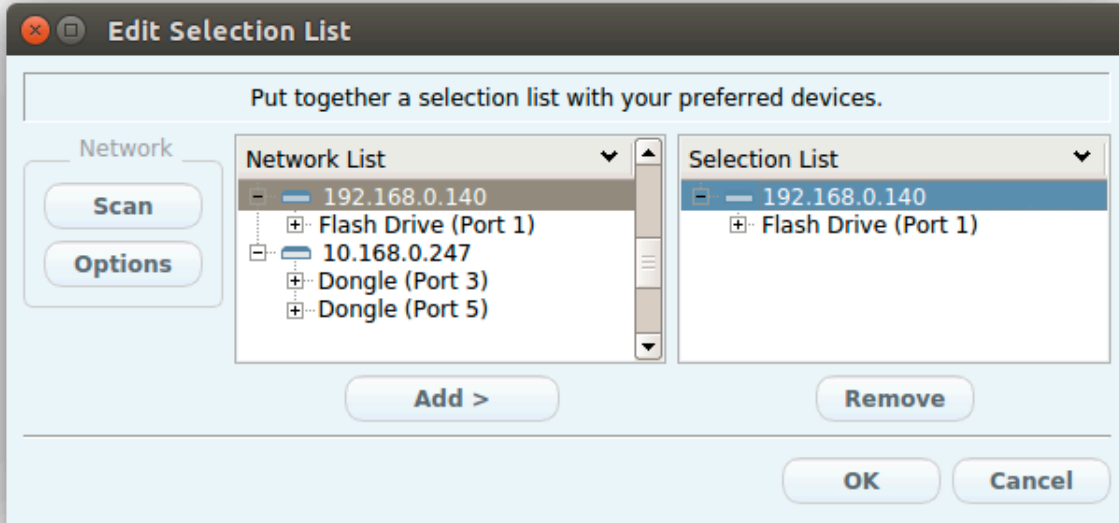

Figure 5: SEH UTN Manager – Edit Selection List

### Adding a INU Server via IP Address

- ✓ The SEH UTN Manager (complete version) is installed on the client ⇒ 11.
  - ✓ You know the IP address of the INU server.
1. Start the SEH UTN Manager.
  2. Select **UTN server – Add**.  
The **Add server** dialog appears.
  3. In the **Host name or IP address** box, enter the IP address of the INU server.
  4. If you changed the UTN port or UTN SSL port (⇒ 37), define the respective port numbers in the **UTN-Port** and **UTN-SSL-Port** box.
  5. Click **OK**.  
↳ The INU server and the connected USB devices is shown in the selection list.

## 5.2 How to Establish a Connection to a USB Device

To connect a USB device to the client, a point-to-point-connection is established between the client and the USB port of the INU server to which the USB device is connected. The USB device can then be used as if it were directly connected to the client.



### Important:

Special case of compound USB devices

When connecting certain USB devices to a USB port of the INU server, the selection list displays several USB devices on this port. These are compound USB devices. They consist of a hub and one or more USB devices that are all integrated into a single housing.

If the connection is established to a port with a connected compound USB device, all USB devices shown will be connected to the user's client. In this case, each integrated USB device occupies a virtual USB port of the INU server. The INU server is limited in its number of USB ports: 10. If the limit is reached, no further USB devices can be used on this INU server.

- ✓ The SEH UTN Manager (complete version) is installed on the client ⇒ 11.
  - ✓ The USB port is shown in the selection list ⇒ 42.
  - ✓ All provisions (driver installation, etc.) necessary to operate the USB device locally (i.e. connected directly to the client) should have been met on the client. Ideally, the USB device has been connected and operated on the client locally according to the instructions of the manufacturer.
  - ✓ The USB port is not connected to another client.
1. Start the SEH UTN Manager.
  2. Select the port from the selection list.
  3. From the menu bar, select **Port – Activate**.
- ↳ The connection between the USB device and client is established.

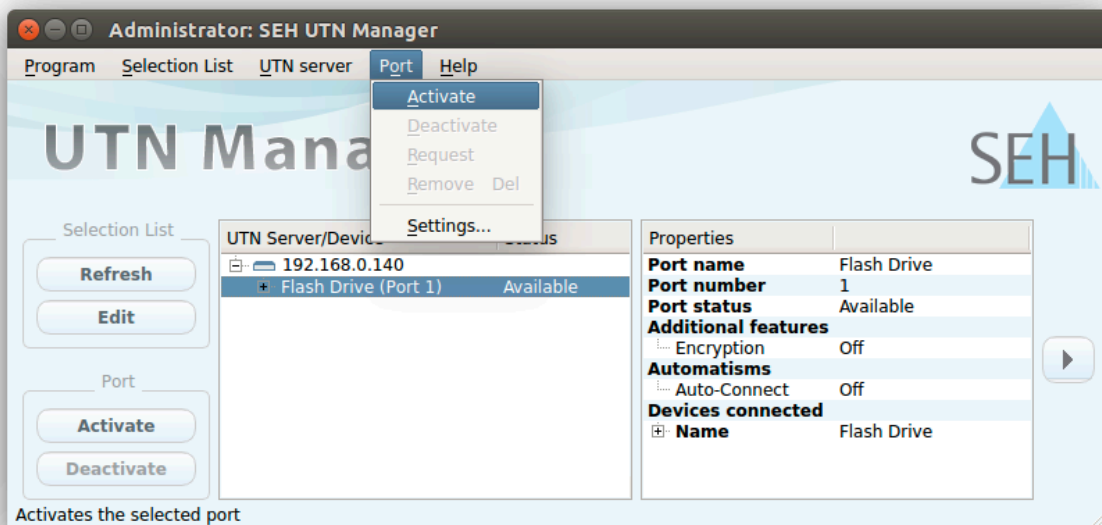

Figure 6: SEH UTN Manager – USB port activation



## 5.3 How to Cut the Connection between the USB Device and the Client

If a USB device is connected to a client, the connection is of a point-to-point type. As long as the connection is established, other users cannot connect the USB device to their client and thus cannot use it. For this reason, you have to cut the connection once you do not use the USB device any longer.

To cut the connection between USB device and client, you deactivate the connection between the client and the USB port of the INU server to which the USB device is connected.

- Usually the connection is cut by the user via the SEH UTN Manager ⇒ [45](#).
- In addition, the administrator can deactivate the connection via the INU Control Center ⇒ [45](#).
- You can also set up an automatic deactivation (Auto Disconnect) ⇒ [47](#).

### Cutting the Device Connection via the SEH UTN Manager

- ✓ The SEH UTN Manager (complete version) is installed on the client ⇒ [11](#).
- ✓ The USB port is shown in the selection list ⇒ [42](#).
- ✓ The USB port is connected to your client ⇒ [44](#).

1. Start the SEH UTN Manager.
2. Select the port from the selection list.
3. Select **Port – Deactivate** from the menu bar.  
↳ The connection will be deactivated.

### Cutting the Device Connection via the INU Control Center

- ✓ A USB port is connected to your client ⇒ [44](#).
1. Start the INU Control Center.
  2. Select **START**.
  3. Choose the active connection from the **Attached devices** list and click the  icon.
  4. Confirm the security query.  
↳ The connection will be deactivated.

## 5.4 How to Request an Occupied USB Device

If a USB device is connected to a client, the connection is of a point-to-point type. As long as the connection is established, other users cannot connect the USB device to their client and thus cannot use it.

If you want to use an occupied USB device, you can request it. The other user will receive a release request in form of a pop up. If the user follows your request and releases the USB device by deactivating the connection to the USB device, the connection between the USB device and your client will automatically be activated.

- ✓ The SEH UTN Manager (complete version) is installed on the client ⇒ 11.
- ✓ The SEH UTN Manager (complete version) is installed on the client of the user who uses the USB device ⇒ 11.
- ✓ The SEH UTN Manager (complete version) is running with graphical user interface on both clients.
- ✓ The USB port is shown in the selection list ⇒ 42.
- ✓ The USB port is connected to another client ⇒ 44 (but not via Auto-Connect).

1. Select the port from the selection list.
2. Select **Port – Request** from the menu bar.
  - ↳ The release request will be sent.

## 5.5 How to Automate USB Device Connections and Program Starts

Connections to USB ports of the INU server and the connected USB devices can be automated. Simple to complex processes can be implemented.

- Automatic Connection If a USB Device Is Connected (Auto-Connect) ⇒ 47
- Automatic Deactivation of the Connection after a Time Defined (Auto-Disconnect) ⇒ 47



*This chapter describes features of the SEH UTN Manager with which automatisms are set up. Users who have expert knowledge in scripting should use the command line tool 'utnm' ⇒ 52.*

### Automatic Connection If a USB Device Is Connected (Auto-Connect)

Auto-Connect automatically establishes a connection to a USB port and the connected USB device as soon as a USB device is connected to the USB port. Auto-Connect must be activated for each USB port and works for all USB devices which are connected to the USB port.

- ✓ The SEH UTN Manager (complete version) is installed on the client ⇒ 11.
  - ✓ The USB port is shown in the selection list ⇒ 42.
  - ✓ You are logged on to the client as administrator.
1. Start the SEH UTN Manager.
  2. Select the UTN server from the selection list.
  3. From the menu bar, select **UTN server – Activate Auto-Connect**.  
The dialog **Activate Auto-Connect** appears.
  4. Tick the option for the desired USB ports.
  5. Click **OK**.
- ↳ The setting will be saved. The connection to the USB port and the connected USB device is automatically and immediately activated. If you disconnect the USB device and reconnect it, the connection is again automatically established.



#### Important:

If you manually deactivate an established USB port connection that was activated by Auto-Connect, the Auto-Connect setting will be deactivated as well. If you want to use Auto-Connect again, you will have to configure it anew later on.

### Automatic Deactivation of the Connection after a Time Defined (Auto-Disconnect)

Auto-Disconnect deactivates the connection to a USB port and the connected USB device after a previously defined time. 2 minutes before time runs out, the user will receive a notification and is asked to deactivate their connection in order to prevent data loss and error states. Optionally, a one-off prolongation of the connection by the duration of the defined time can be activated. In this case, the user can choose to prolong the connection or decline it when the notification pops up.

Auto-Disconnect allows a large number of network participants to access a small number of devices and avoids idle times.



*You can be notified if a connection is automatically disconnected and the port thus is free. For this purpose, set up a notification if the USB port is available ⇒ 49.*

- ✓ The SEH UTN Manager (complete version) is installed on the client ⇒ 11.
  - ✓ The INU server is displayed in the 'Automatic Device Disconnect' area ⇒ 42.
  - ✓ You are logged on to the client as administrator.
1. Start the SEH UTN Manager.

2. Select the SEH UTN server in the selection list.
  3. In the SEH UTN Server menu, select the command "Activate Auto Disconnect".  
The Activate **Auto Disconnect** dialog appears.
  4. Activate the option for the desired USB ports.
  5. Define the desired time period (10-9999 minutes).
  6. Activate the **Extension** option if required.
  7. Select the **OK** button.
- ↳ The setting is saved

## 5.6 How to Find Status Information on USB Ports and USB Devices

You can check the status of USB ports and USB devices at any given time. You can also configure automatic messages. You can use automatic messages to be notified when a USB port becomes available or to receive information about the connection duration.



### Important:

Automatic messages might not appear.

Messages depend on the system's window manager. Due to the multitude of Linux varieties (and window managers) notification via message might not be supported.

- Displaying Status Information ⇒ 49
- Notification If a USB Port Becomes Available ⇒ 49
- Message about the Duration of a Connection ⇒ 49

### Displaying Status Information

- ✓ The SEH UTN Manager (complete version) is installed on the client ⇒ 11.
  - ✓ The USB port is shown in the selection list ⇒ 42.
1. Start the SEH UTN Manager.
  2. Select the USB port from the selection list.
    - ↳ The status information is displayed in the **Properties** area.

### Notification If a USB Port Becomes Available

You will receive a message once a network participant deactivates the connection to a USB port and the connected USB device.

- ✓ The SEH UTN Manager (complete version) is installed on the client ⇒ 11.
  - ✓ The USB port is shown in the selection list ⇒ 42.
1. In the selection list, select the port.
  2. In the menu bar, select **Port – Settings**.  
The **Port Settings** dialog appears.
  3. Tick the option under **Messages**.
  4. Click **OK**.
    - ↳ The setting will be saved.

### Message about the Duration of a Connection

You will receive a message if one of your connections to a USB port and the connected USB device exceeds a defined time period.

- ✓ The SEH UTN Manager (complete version) is installed on the client ⇒ 11.
1. In the menu bar, select **Program–Options**.  
The **Options** dialog appears.
  2. Select the **Program** tab.
  3. In the **Messages** area, tick the option.
  4. Define the desired duration.
  5. Click **OK**.
    - ↳ The setting will be saved.

## 5.7 How to Use the Selection List and Manage User Access Rights with It

The selection list is the main element in the SEH UTN Manager and shows all embedded INU servers. USB devices can only be used if the INU server to which they are connected is on the list (⇒ 42). By controlling the selection list you consequently control the user's access to INU servers and the connected USB devices.

By default, all client users use the global selection list in the SEH UTN Manager. However, you can set a user selection list for the client users. This list can be compiled by the users themselves. Alternatively, you as client administrator restrict user rights and provide a list with which only the INU servers you define can be used.

Table 12: Differences in global and user selection list

### Global Selection List

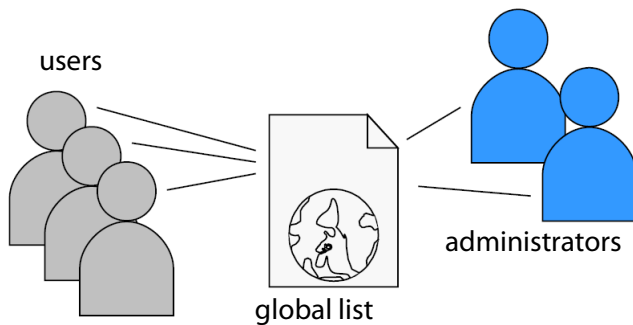

### User Selection List

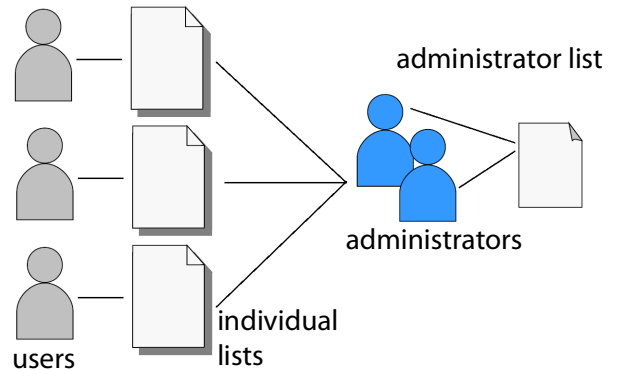

- All users of a client use the same selection list.
- The users can access all devices listed in the selection list. (Provided that no security mechanisms have been specified via the INU Control Center.)
- List is stored at: /etc
- The selection list can be edited by administrators.
- Each user has their own selection list. All administrators have the same selection list.
- The users can access all devices listed in the selection list. (Provided that no security mechanisms have been specified via the INU Control Center.)
- List ('ini'-file) is stored at:
 

```
$HOME/.config/SEH Computertechnik GmbH/SEH UTN Manager.ini
```

 (\$HOME is an environment variable for the user folder in Linux; the path for the current user can be determined with using command line: `echo $HOME`)
   
Example Ubuntu 20.04.0:
 

```
echo $HOME returns /Usershome/User name
```

 +
 

```
.config/SEH Computertechnik GmbH/SEH UTN Manager.ini
```

 Complete path to the ini file:
 

```
/Usershome/User name/.config/SEH Computertechnik GmbH/SEH UTN Manager.ini
```
- The selection list can be edited by administrators or by users with write access to the ini-file. Users with read-only access to the ini-file cannot edit the selection list and have limited access to SEH UTN Managers functions.



Which functions (selection list editing etc.) can be used in the SEH UTN Manager depends on the selection list type (global/user) and user account type on the client (administrator/user; user with/without write access to ini-file). For a detailed breakdown see 'SEH UTN Manager – Feature Overview' ⇒ 105.

- Setting Up the Global Selection List for All Users ⇒ 51
- Providing User Selection Lists ⇒ 51
- Restrict Write Access to the 'SEH UTN Manager.ini'-file ⇒ 51

### Setting Up the Global Selection List for All Users

The global selection list is used by default.

- ✓ The SEH UTN Manager (complete version) is installed on the client ⇒ 11.
  - ✓ You are logged on to the system as administrator.
1. Start the SEH UTN Manager.
  2. Compose the selection list ⇒ 42.
  3. In the menu bar, select **Program–Options**.  
The **Options** dialog appears.
  4. Select the tab **Selection List**.
  5. Tick **Global selection list**.
  6. Click **OK**.
- ↳ The setting will be saved. All users of a client use the same selection list.

### Providing User Selection Lists

- ✓ The SEH UTN Manager (complete version) is installed on the client ⇒ 11.
  - ✓ You are logged on to the system as administrator.
1. Start the SEH UTN Manager.
  2. In the menu bar, select **Program–Options**.  
The **Options** dialog appears.
  3. Select the tab **Selection List**.
  4. Tick **User selection list**.
  5. Click **OK**.

Optional: With the following steps you provide a predefined selection list.

6. Create a selection list with the desired devices ⇒ 42.
  7. In the menu bar, select **Selection List–Export**.  
The **Export to** dialog appears.
  8. Save the file 'SEH UTN Manager.ini' to the user directories:  
\$HOME/.config/SEH Computertechnik GmbH/SEH UTN Manager.ini (⇒ Table 12 50)
- ↳ The setting will be saved. Each user uses their individual (predefined) selection list. The administrators share one selection list.

### Restrict Write Access to the 'SEH UTN Manager.ini'-file

User selection lists can be set up and edited by the users themselves.

In order to restrict users to just the INU servers you want them to have access to, you can provide a list to users. To do so, you as administrator store a predefined list for the user (⇒ 51) and limit the user to read-only access to the 'SEH UTN Manager.ini'-file. By limiting the user to read-only access, all SEH UTN Manager functions concerning the selection list are disabled for the user.

Use the usual methods of your operating system to turn the ini-files into read-only files. For more information, read the documentation of your operating system.

## 5.8 How to Use the SEH UTN Manager without Graphical User Interface (utnm)

The SEH UTN Manager is available in two versions ⇒ 11. It can be used without graphical user interface in the minimal version. To do so, the tool 'utnm' is utilized to use UTN features via the console of the operating system:

- directly, by entering commands in a certain syntax and executing them
- via scripts which contain commands in a certain syntax that will be executed automatically and step by step by the command line interpreter



*Use scripts to automate frequently recurring command sequences such as port activations.*



*The execution of scripts can be automated as well, e.g. by means of login scripts.*

- Syntax ⇒ 52
- Commands ⇒ 52
- Return ⇒ 54
- Using utnm via Console ⇒ 55
- Creating a utnm Script ⇒ 55

### Syntax

```
utnm -c "command string" [-<command>]
```

The executable file 'utnm' can be found in `/usr/bin/`.

### Commands

Rules for commands:

- Underlined elements are to be replaced by the appropriate values (e.g. `INU server` = IP address or host name of a INU server)
- elements in square brackets are optional.
- not case-sensitive
- only the ASCII format can be read.



Command	Description
<code>-c "<u>command string</u>"</code>	Runs a command. The command is specified in greater detail by the command string. Command strings:
or	
<code>--command "<u>command string</u>"</code>	<ul style="list-style-type: none"> <li>• <code>activate <u>server port number</u></code> Activates the connection to a USB port and the connected USB device.</li> <li>• <code>activate <u>server vendor ID (VID) product ID (PID)</u></code> Activates the connection to a USB port and the first free connected USB device with the defined IDs, if several identical USB devices are connected to the INU server.</li> <li>• <code>deactivate <u>server port number</u></code> Deactivates the connection to a USB port and the connected USB device.</li> <li>• <code>set autoconnect=true false <u>server port number</u></code> Enables/disables Auto-Connect (⇒ 47) for the USB port.</li> <li>• <code>set portkey='port key' <u>server port number</u></code> Stores a USB port key (⇒ 64) locally on the system. This way, the USB port key is always automatically sent and must not be specified each time with the command <code>-k <u>USB port key</u> respectively <code>--key <u>USB port key</u></code> (see below). (To remove the USB port key use the command string <code>set portkey= <u>server port number</u></code>)</code></li> </ul>
	<p><b>Important:</b></p> <p>The command only sets the key permanently to make the USB device available.</p> <p>The USB port key configuration is done via the INU Control Center ⇒ 64.</p>
	<ul style="list-style-type: none"> <li>• <code>find</code> Searches for all INU servers in the network segment and shows the INU servers found with IP address, MAC address, model and software version.</li> <li>• <code>getlist <u>server</u></code> Shows an overview of the USB devices connected to the INU server (including port number, vendor ID, product ID, vendor name, product name, device class, and status).</li> <li>• <code>state <u>server port number</u></code> Displays the status of the USB device connected to the USB port.</li> </ul>
<code>-h</code>	Shows the help page.
or	
<code>--help</code>	

Command	Description
-k <u>USB port key</u> or --key <u>USB port key</u>	Specifies a USB port key ⇒ <a href="#">64</a> .   <b>Important:</b> The command only enters the key to make the USB device available. Use the command -c " <u>command string</u> " respectively --command " <u>command string</u> " to permanently store a USB port key on the system so that it is sent automatically each time (see above). The USB port key configuration is done via the INU Control Center ⇒ <a href="#">64</a> .
-mr or --machine readable	Separates the output of the command string <code>getlist</code> with tabulators and the output of <code>find</code> with commas.
-nw or --no-warnings	Suppresses warning messages.
-o or --output	Shows the output in the command line.
-p <u>port number</u> or --port <u>port number</u>	Uses an alternative UTN port. Use this command if you have changed the UTN port number (⇒ <a href="#">37</a> ).
-q or --quiet	Suppresses the output.
-sp <u>port number</u> or --ssl-port <u>port number</u>	Uses an alternative UTN port with SSL/TLS encryption. Use this command if you have changed the UTN SSL port number (⇒ <a href="#">37</a> ).
-t <u>seconds</u> or timeout <u>seconds</u>	Specifies a timeout for the command strings <code>activate</code> and <code>deactivate</code> .
-v or --version	Shows version information about <code>utnm</code> .

## Return

After a command is executed, a return indicates success or failure of the process. The returned information is a status combined with a return value (return code). If the output is suppressed ('--quiet' ⇒ [54](#)), only the value is returned.

The return can be used to determine how the process proceeds, e.g. in a script.

Return Value	Description
0	The command was executed successfully.
20	The USB device connected to the USB port could not be plugged in.
21	The USB device connected to the USB port could not be plugged out.
22	The USB device connected to the USB port could not be ejected.
23	The USB device connected to the USB port is already plugged in.
24	The connection to the USB port and the connected USB device has already been deactivated or there is no device connected to the USB port.
25	The USB port including the connected USB device is connected to another user.
26	There is no device connected to the USB port or the USB port key (⇒ ¶64) is missing respectively wrong.
29	UTN Action (⇒ ¶47) with 'Use the first free device': There is no USB device with the defined VID and PID connected to the USB port.
30	The isochronous mode is not supported.
31	UTN driver error. Please contact the SEH Computertechnik GmbH support ⇒ ¶5.
40	No network connection to the INU server.
41	An encrypted connection (SSL/TLS) to the INU server cannot be established.
42	The connection to the UTN service cannot be established.
43	The DNS resolution failed.
44	Insufficient rights (administrative rights required).
47	This feature is not supported.
200	General error (with error code).

### Using utnm via Console

- ✓ The SEH UTN Manager is installed on the client ⇒ ¶11.
- ✓ You know the INU server's IP address or host name.

1. Open a **Console**.
2. Enter the sequence of commands; see 'Syntax' ⇒ ¶52 and 'Commands' ⇒ ¶52.
3. Confirm your entry.
  - ↳ The sequence of commands will be run.

Example: Activating a USB device on port 3 of the INU server with the IP address 10.168.1.167

```
utnm -c "activate 10.168.1.167 3"
```

### Creating a utnm Script

- ✓ The SEH UTN Manager is installed on the client ⇒ ¶11.
  - ✓ You know the INU server's IP address or host name.
  - ✓ You know how to create and use scripts in your operating system. If needed, refer to the documentation of your operating system.
1. Open a text editor.
  2. Enter the sequence of commands; see 'Syntax' ⇒ ¶52, 'Commands' ⇒ ¶52, and 'Return' ⇒ ¶54.
  3. Save the file as executable script on your client.
    - ↳ The script is saved and can be used.



















## 6 Security

The INU server can be protected with various security mechanisms. These mechanisms secure the INU server itself as well as the connected USB devices. In addition, you can integrate the INU into the protection mechanisms implemented in your network.

- How to Encrypt the USB Connection ⇒ [§57](#)
- How to Encrypt the Connection to the INU Control Center ⇒ [§59](#)
- How to Define the Encryption Strength for SSL/TLS Connections ⇒ [§60](#)
- How to Protect Access to the INU Control Center (User Accounts) ⇒ [§62](#)
- How to Block Ports of the INU Server (TCP Port Access Control) ⇒ [§63](#)
- How to Control Access to USB Devices ⇒ [§64](#)
- How to Block USB Device Types ⇒ [§66](#)
- How to Use Certificates ⇒ [§67](#)
- How to Configure Network Authentication (IEEE 802.1X) ⇒ [§72](#)



### Important:

Protect the access to the INU Control Center with user accounts so that security related settings cannot be tampered with by unauthorized persons.



*You can also use SNMP and VLAN for security:*

- 'How to Configure SNMP' ⇒ [§26](#)
- 'How to Use the INU Server in VLAN Environments' ⇒ [§30](#)

## 6.1 How to Encrypt the USB Connection

To secure the USB connections, you encrypt the data transfer between the clients and the USB devices connected to the INU server. The encryption has to be activated individually for each connection, i.e. for each USB port.



**Important:**

Only payload will be encrypted. Control and log data will be transmitted without encryption.

For encryption the protocols SSL (Secure Sockets Layer) and its successor TLS (Transport Layer Security) are used. The encryption strength is defined via the encryption protocol and level ⇒ 60.



**WARNING**

The SEH UTN Manager does not support the encryption level **Low**. If you set up **Low** in combination with an encrypted USB connection, a connection cannot be established.

Use an encryption level as high as possible.

If connections are encrypted, client and INU server communicate via the UTN SSL port. By default, that is port 9443. If the port is already used in your network, e.g. for another application, you can change the port number ⇒ 37.

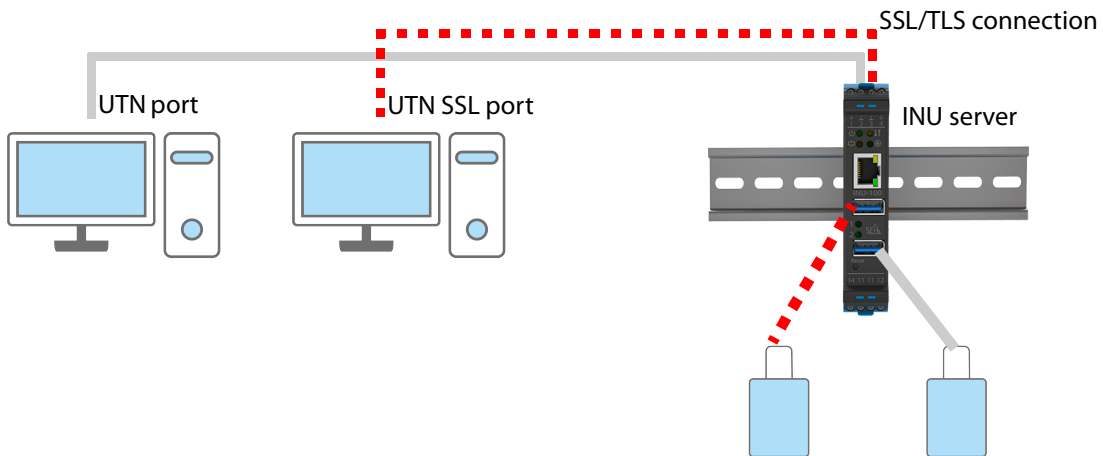

Figure 7: INU Server – SSL/TLS connection in the network

1. Start the INU Control Center.
  2. Select **SECURITY – Encryption**.
  3. Enable the encryption for the USB port.
  4. To confirm, click **Save**.
- ↳ The data transfer between the clients and the USB device will be encrypted.



The encrypted connection will be displayed client-side in the SEH UTN Manager under **Properties**.

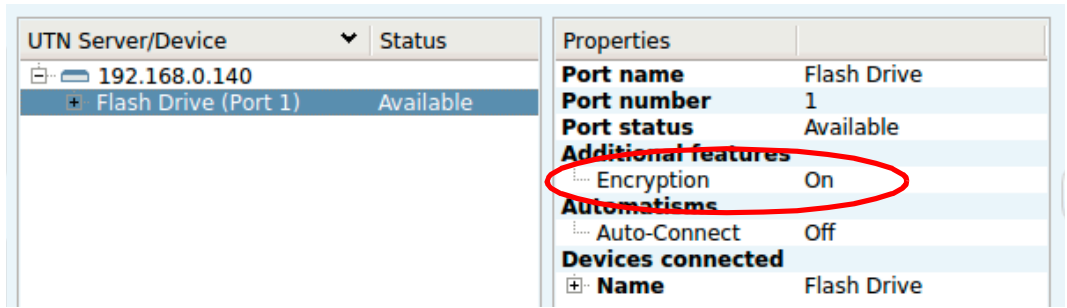

Figure 8:SEH UTN Manager – encryption

## 6.2 How to Encrypt the Connection to the INU Control Center

You can protect the connection to the INU Control Center by encrypting it with the protocol SSL (Secure Sockets Layer) and its successor TLS (Transport Layer Security).

- HTTP: unencrypted connection
- HTTPS: encrypted connection

The encryption strength is defined via the encryption protocol and level ⇒ 60. When an encrypted connection is to be established, the client asks for a certificate via a browser (⇒ 67). This certificate must be accepted by the browser; read the documentation of your browser software.



### WARNING

Current browsers do not support low security settings. With them a connection cannot be established.

Do not use the following combination: Encryption protocol **HTTPS** and encryption level **Low**.

1. Start the INU Control Center.
  2. Select **SECURITY – Device access**.
  3. In the **Connection** area, tick **HTTP/HTTPS** or **HTTPS only**.
  4. To confirm, click **Save**.
- ↳ The setting will be saved.

## 6.3 How to Define the Encryption Strength for SSL/TLS Connections

Some connections to and from the INU server can be encrypted with the protocol SSL (Secure Sockets Layer) and its successor TLS (Transport Layer Security):

- Email: POP3 (⇒ 28)
- Email: SMTP (⇒ 28)
- Web access to the INU Control Center: HTTPS (⇒ 59)
- Data transfer between the clients and the INU server (and the connected USB devices): USB connection (⇒ 60)

The encryption strength and thus the safety of the connection is defined via the encryption protocol and level. You can choose both.

Each encryption level is a collection of what is called cipher suites. A cipher suite in turn is a standardized sequence of four cryptographic algorithms that are used to establish a secure connection. Based on their encryption strength they are grouped to encryption levels. Which cipher suites are supported by the INU server, i.e. are part of an encryption level, depends on the chosen encryption protocol. You can choose between two encryption levels:

- Any: The encryption is automatically negotiated by both communicating parties. The strongest encryption supported by both parties will always be chosen.
- Low: Only cipher suites with a low encryption are used. (Fast data transfer)
- Medium
- High: Only cipher suites with a strong encryption are used. (Slow data transfer)

When a secure connection is established, the protocol to be used and a list of supported cipher suites are sent to the communication partner. A cipher suite is agreed upon that will be used later on. The strongest cipher suite that is supported by both parties will be used by default.



### WARNING

If the communication partner of the INU server does not support the protocol selected and/or if there is no cipher suite that is supported by both parties, the SSL/TLS connection will not be established.

If problems occur, select different settings or reset the parameters of the INU server ⇒ 80.



*If you want the INU server and its communication partner to automatically negotiate the settings, set both options to **Any**. With these settings, the chances that a secure connection can be established are the highest.*

1. Start the INU Control Center.
2. Select **SECURITY – SSL connections**.
3. In the **Encryption protocol** area, select the desired protocol.



### WARNING

Current browsers do not support **SSL**. If you use an up-to-date browser and set the combination **SSL** and **HTTPS only** for accessing the INU Control Center (⇒ 59), a connection cannot be established.

Use TLS (and not SSL).



4. In the **Encryption level** area, select the desired level.

**WARNING**

Current browsers do not support cipher suites from the **Low** level. If you use an up-to-date browser and set the combination **Low** and **HTTPS only** for accessing the INU Control Center (⇒ 59), a connection cannot be established.

Use an encryption level as high as possible.

**WARNING**

The SEH UTN Manager does not support the encryption level **Low**. If you set up **Low** in combination with an encrypted USB connection (⇒ 57), a connection cannot be established.

Use an encryption level as high as possible.

5. To confirm, click **Save**.

↳ The setting will be saved.



*Detailed information on the individual SSL/TLS connections (e.g. supported cipher suites) can be found on the details page **SSL connection status – Details**.*

## 6.4 How to Protect Access to the INU Control Center (User Accounts)

By default, everyone who can find the INU in the network can access its INU Control Center. To protect the INU from unwanted configuration changes, you can set up two user accounts:

- Administrator: Complete access to the INU Control Center. The user can see all pages and change settings.
- Read-only user: Very restricted access to the INU Control Center. The user can only see the 'START' page.

If you have set up user accounts, a login screen is displayed when the INU Control Center is started. You can choose between two login screens:

- List of users: User names are displayed. Only the password has to be entered.
- Name and password dialog: Neutral login screen in which user name and password have to be entered. (better protection)

A user account allows for multiple logins, i.e. the account can be used by a single user or by a group of users. Up to 16 users can be logged in at the same time.



### Important:

The user accounts for INU Control Center access are also used for SNMP ⇒ 26. Consider this when setting up user accounts.

For stronger security, you can use a session timeout. If there is no activity within a defined timeout, the user will automatically be logged out.

1. Start the INU Control Center.
2. Select **SECURITY – Device access**.
3. Define the two user accounts. To do this, in the area **User accounts** enter a **User name** and **Password** respectively.



*You can show the typing if you want to make sure that there are no typing errors in the password.*

4. Tick **Restrict Control Center access**.
5. Choose the login screen type: **list of users** or **name and password**.
6. Tick **Session timeout** and into the **Session duration box** enter the time in Minutes after which the timeout is to be effective.
7. To confirm, click **Save**.
  - ↳ The settings will be saved.

## 6.5 How to Block Ports of the INU Server (TCP Port Access Control)

You can restrict access to the INU server by blocking ports with the 'TCP port access control'. If a port is blocked, the protocols respectively services using this port cannot establish a connection with the INU server. Thus attackers have less room for attack.

The security level defines which port types are blocked:

- UTN access (blocks UTN ports)
- TCP access (blocks TCP ports: HTTP/HTTPS/UTN)
- All ports (blocks IP ports)

You have to define exceptions so that your desired network elements, e.g. clients or DNS servers, can establish a connection with the INU server.



### WARNING

The 'test mode' is active by default so that you can test your settings without locking yourself out. Your settings will be active until the INU is restarted, afterwards access is no longer restricted.

After you have successfully tested your settings, you have to deactivate the test mode so that access control is permanent.

1. Start the INU Control Center.
2. Select **SECURITY – TCP port access**.
3. Tick **Port access control**.
4. In the **Security level** area, select the desired protection
5. In the **Exceptions** area, define the network elements that are to have access to the INU server. To do this, enter the IP or MAC (hardware) addresses and tick the options.



### Important:

- MAC addresses are not delivered through routers!
- The use of wildcards (\*) allows you to define subnetworks.

6. Make sure that the **Test mode** is enabled.
7. Click **Save & Restart** to confirm.  
The settings will be saved.  
The port access control is activated until the device is restarted.
8. Check the port access and if the INU Control Center can be reached.



### Important:

If the INU Control Center cannot be reached, restart the INU server ⇒ 76.

9. Deactivate the **Test mode**.
10. Click **Save & Restart** to confirm.  
↳ The settings will be saved.

## 6.6 How to Control Access to USB Devices

You can restrict the access to the USB ports and the connected USB devices:

- USB port key control A key is defined for the USB port. Neither the USB port nor the connected USB device are shown in the SEH UTN Manager, i.e. the USB device cannot be used. Only if the key for the USB port is entered in the SEH UTN Manager, the USB port and the connected USB device appear.
- USB port device assignment: A certain USB device is assigned to a USB port. This is achieved by linking the USB port and USB device through the vendor ID (short VID) and product ID (short PID) of the USB device. The combination of VID and PID is specific to a certain USB device model which means that only USB devices of this specific model can be used on the USB port. This way you can assure, that (security) settings cannot be circumvented by connecting USB devices to other ports.



*Power off unused ports to increase security* ⇒ 36.

- Setting Up USB Port Keys ⇒ 64
- Entering a USB Port Key (Unlocking a USB Device) ⇒ 64
- Setting up USB Port Device Assignment ⇒ 65

### Setting Up USB Port Keys

A key for a USB port is defined in the INU Control Center.

1. Start the INU Control Center.
  2. Select **SECURITY – USB port access**.
  3. For the desired USB port, go to the **Method** list and select **Port key control**.
  4. Click **Generate key** or enter a freely definable key (max. 64 ASCII characters) into the **Key** box.
  5. To confirm, click **Save**.
- ↳ The settings will be saved. Access to the USB device is protected.



*To deactivate the feature, go to the **Method** list and select ---.*

### Entering a USB Port Key (Unlocking a USB Device)

To gain access to a USB device that is protected with the USB port key control, the corresponding key must be entered in the SEH UTN Manager on the client.

1. Start the SEH UTN Manager.
  2. In the selection list, select the INU server.
  3. From the menu bar, select **UTN server – Set USB Port Keys** .  
The **Set USB Port Keys** dialog appears.
  4. Enter the key for the relevant USB port.
  5. Click **OK**.
- ↳ Access is granted. The USB port and the connected USB device are shown in the selection list and can be used.

### Setting up USB Port Device Assignment

1. Start the INU Control Center.
  2. Select **SECURITY – USB port access**.
  3. For the desired USB port, go to the **Method** list and select **Device assignment**.
  4. Click **Reallocate device**.  
The **USB device** box shows the VID and PID of the USB device.
  5. To confirm, click **Save**.
- ↳ The settings will be saved. Only the assigned USB device model can be operated on the USB port.



*To deactivate the feature, go to the **Method** list and select ---.*

## 6.7 How to Block USB Device Types

USB devices are grouped into classes according to their function. For example, input devices such as keyboards belong to the group 'Human Interface Device' (HID).

USB devices may present themselves as HID class USB devices while they are actually used for abuse (known as 'BadUSB').

In order to protect the INU server, you can block input devices of the HID class.

1. Start the INU Control Center.
2. Select **SECURITY – Device access**.
3. Tick/clear **Disable input devices (HID class)** in the **USB devices** area.
4. To confirm, click **Save**.  
↳ The setting will be saved.

## 6.8 How to Use Certificates

The INU server has its own certificate management. Digital certificates are data sets, which confirm the identity of a person, object, or organization. In TCP/IP networks they are used to encrypt data and to authenticate communication partners.

The INU needs a certificate for:

- participating in the authentication mechanisms EAP-TLS, EAP-TTLS and PEAP ⇒ 672
- protecting email communication (POP3/SMTP via SSL/TLS) ⇒ 628
- protecting the connection between the clients and the connected USB devices ⇒ 657
- protecting the connection to the INU Control Center (with HTTPS) ⇒ 659

The following certificates can be used in the INU server:

- 1 self-signed certificate  
Certificate generated by the INU server and signed by the INU server itself. The certificate confirms the INU server's identity.
- 1 client certificate, i.e. 1 requested certificate or 1 PKCS#12 certificate  
The client certificate confirms the identity of the INU server with the help of an additional trustworthy authority which is the certification authority (short CA).
  - Requested certificate: As first step, a certificate request is generated on the INU server and then the request is sent to a certification authority. In the second step, the certification authority creates a certificate based on the request for the INU server and signs it.
  - PKCS#12 certificate Exchange format for certificates. You have a certification authority generate a certificate which is stored in password-protected PKCS#12 format for the INU server. Then you transport the PKCS#12 file to the INU server and install it (and thus the certificate in it).
- 1 S/MIME certificate  
The INU server uses the S/MIME Certificate to sign and encrypt emails which is sends. The corresponding private key (PKCS#12 format) has to be installed as certificate of it's own in the email program (Mozilla Thunderbird etc.) so that emails can be verified and, if necessary, decrypted.
- 1–32 CA certificates, also known as root CA certificates.  
Certificates which are issued for a certification authority and confirm its identity. They are used for verifying certificates that have been issued by the respective certification authority. In case of the INU server these are the certificates of communication partners to verify their identity (chain of trust). Thus multi-level public key infrastructures (PKIs) are supported.



### Important:

Upon delivery, a default certificate is stored in the INU server. This certificate is issued by SEH Computertechnik GmbH for each device specifically.

- Having a Look at Certificates ⇒ 668
- Creating a Self-Signed Certificate ⇒ 668
- Request and Install Certificate (Requested Certificate) ⇒ 669
- Installing a PKCS#12 Certificate ⇒ 670
- Installing an S/MIME Certificate ⇒ 670
- Installing a CA Certificate ⇒ 670
- Deleting Certificates ⇒ 671

### Having a Look at Certificates

- ✓ A certificate is installed on the INU server.
- 1. Start the INU Control Center.
- 2. Select **SECURITY – Certificates**.
- 3. Select the certificate via the icon .
- ↳ The certificate is displayed.

### Creating a Self-Signed Certificate



**Important:**

Only one self-signed certificate can be installed on the INU server. To create a new certificate, you must first delete the existing certificate ⇒ 71.



- 1. Start the INU Control Center.
- 2. Select **SECURITY – Certificates**.
- 3. Click **Self-signed certificate**.
- 4. Enter the relevant parameters; ⇒ Table 13 68.
- 5. Click **Create/Install**.
- ↳ The certificate will be created and installed. This may take a few minutes.

Table 13: Parameters for the Creation of Certificates

Parameters	Description
Common name	Freely definable certificate name. (max. 64 characters)
	 <i>Use the IP address or host name of the INU server, so that you can clearly match device and certificate.</i>
Email address	Email address of the person responsible for the INU server. (max. 40 characters; optional)
Organization name	Name of the company which uses the INU server. (max. 64 characters)
Organizational unit	Name of a department or subsection in the company. (max. 64 characters; optional)
Location	Location of the company. (max. 64 characters)
State name	State where the company is based. (max. 64 characters)
Domain component	Allows you to enter additional attributes. (Optional entry)
SAN (multi-domain)	Allows you to enter Subject Alternative Names (SAN). Is used to enter additional host names (e.g. domains). (Optional entry, max. 255 characters)
Country	Country where the company is based. Enter the two-digit country code according to ISO 3166. Examples: DE = Germany, GB = Great Britain, US = USA



Parameters	Description
Issued on	Date from which on the certificate is valid.
Expires on	Date from which on the certificate becomes invalid.
RSA key length	Defines the length of the RSA key used: <ul style="list-style-type: none"> <li>• 512 bit (fast encryption and decryption)</li> <li>• 768 bit</li> <li>• 1024 bit (standard encryption and decryption)</li> <li>• 2048 bit</li> <li>• 4096 bit (slow encryption and decryption)</li> </ul>

### Request and Install Certificate (Requested Certificate)

A certificate that has been issued by a certification authority for the INU server can be used in the INU server. To do this, your first create a certificate request and then send it to the certification authority. Based on the request, the certification authority then creates a certificate specifically for the INU server. You install this certificate in the INU server.



#### Important:

You can only install a requested certificate that has been issued based on the certificate request created on the INU server.

If the files do not match, you have to request a new certificate which is based on the current certificate request. If you want to start over, you must delete the certificate request ⇒ 71.

1. Start the INU Control Center.
2. Select **SECURITY – Certificates**.
3. Click **Certificate request**.
4. Enter the required parameters; ⇒ Table 13 68.
5. Click **Create a request**.  
The certificate request will be created. This may take a few minutes.
6. Select **Upload** and save the requests in a text file.
7. Click **OK**.
8. Send the text file as certificate request to a certification authority.  
The certification authority creates the certificate and gives it to you.



#### Important:

The certificate must be in 'base64' format.

9. Click **Requested certificate**.
10. Enter the password into the **Password** box.
11. Click **Install**.  
↳ The requested certificate is installed in the INU server.

## Installing a PKCS#12 Certificate



### Important:

If a PKCS#12 certificate has already been installed in the INU server, you must first delete the certificate ⇒ 71.

- ✓ The certificate has 'base64' format.
- 1. Start the INU Control Center.
- 2. Select **SECURITY – Certificates**.
- 3. Click **PKCS#12 certificate**.
- 4. Specify the PKCS#12 certificate in the **Certificate file** box.
- 5. Enter the password.
- 6. Click **Install**.
- ↳ The PKCS#12 certificate will be installed in the INU server.

## Installing an S/MIME Certificate



### Important:

If an S/MIME certificate has already been installed in the INU server, you must first delete the certificate ⇒ 71.

- ✓ The certificate has 'pem' format.
- 1. Start the INU Control Center.
- 2. Select **SECURITY – Certificates**.
- 3. Click **S/MIME certificate**.
- 4. Specify the S/MIME certificate in the **Certificate file** box.
- 5. Click **Install**.
- ↳ The S/MIME certificate is installed in the INU server.

## Installing a CA Certificate

- ✓ The certificate has 'base64' format.
- 1. Start the INU Control Center.
- 2. Select **SECURITY – Certificates**.
- 3. Click **CA certificate**.
- 4. Specify the CA certificate in the **Certificate file** box.
- 5. Click **Install**.
- ↳ The CA certificate is installed in the INU server.

## Deleting Certificates



### WARNING

To establish an encrypted (HTTPS ⇒ 59) connection to the INU Control Center, a certificate (self-signed/CA/PKCS#12) is required. If you delete the corresponding certificate, the INU Control Center can no longer be reached.

In this case restart the INU server ⇒ 76. The INU server then generates a new self-signed certificate with which a secured connection can be established.

- ✓ A certificate is installed on the INU server.
- 1. Start the INU Control Center.
- 2. Select **SECURITY – Certificates**.
- 3. Select the certificate to be deleted via the icon .
- The certificate is displayed.
- 4. Click **Delete**.
- ↳ The certificate is deleted.

## 6.9 How to Configure Network Authentication (IEEE 802.1X)

Authentication is the proof and verification of an identity. With it your network is protected from abuse, because only authorized devices have access.

The INU supports authentication according to the IEEE 802.1X standard which is based on EAP (Extensible Authentication Protocol).

If you use authentication according to IEEE 802.1X in your network, the INU server can participate:

- Configuring EAP-MD5 ⇒ 72
- Configuring EAP-TLS ⇒ 72
- Configuring EAP-TTLS ⇒ 73
- Configuring PEAP ⇒ 73
- Configuring EAP-FAST ⇒ 74

### Configuring EAP-MD5

EAP-MD5 (Message Digest #5) is a user-based authentication via a RADIUS server. First, you have to create a user (user name and password) on the RADIUS server for the INU server. Afterwards you set up EAP-MD5 on the INU server.

- ✓ A user account for the INU server is set up on the RADIUS server.
1. Start the INU Control Center.
  2. Select **SECURITY – Authentication**.
  3. From the **Authentication method** list, select **MD5**.
  4. Enter the user name and the password of the user account that is set up for the INU server on the RADIUS server.
  5. Click **Save & Restart** to confirm.
- ↳ The settings will be saved.

### Configuring EAP-TLS

EAP-TLS (Transport Layer Security) is a mutual, certificate based authentication via a RADIUS server. In this method, INU server and RADIUS server exchange certificates through an encrypted TLS connection.

Both RADIUS and INU server require a valid, digital certificate signed by a CA. This requires a PKI (Public Key Infrastructure).



#### WARNING

Follow the instructions below in the given order. If you do not follow the order, the INU server might not be reachable in the network.

In this case, reset the parameters of the INU server ⇒ 80.

1. Create a certificate request on the INU server ⇒ 69.
  2. Create a certificate using the certificate request and the authentication server.
  3. Install the requested certificate on the INU server ⇒ 69.
  4. Install the root CA certificate of the certification authority that has issued the certificate of the authentication server (RADIUS) is installed in the INU server ⇒ 70.
  5. Start the INU Control Center.
  6. Select **SECURITY – Authentication**.
  7. Select **TLS** from the **Authentication method** list.
  8. From the list **EAP root certificate**, select the root CA certificate.
  9. Click **Save & Restart** to confirm.
- ↳ The settings will be saved.

## Configuring EAP-TTLS

In EAP-TTLS (Tunneled Transport Layer Security), a TLS-protected tunnel is used for exchanging secrets. The method consists of two phases:

1. Outer authentication: An encrypted TLS (Transport Layer Security) tunnel is created between INU server and RADIUS server. To do this, the RADIUS server authenticates itself to the INU server using a certificate that was signed by a CA.
  2. Inner authentication: In the tunnel the authentication (via CHAP, PAP, MS-CHAP, or MS-CHAPv2) takes place.
- ✓ A user account for the INU server is set up on the RADIUS server.
  - ✓ For increased security during connection establishment (optional): The root CA certificate of the certification authority that has issued the certificate of the authentication server (RADIUS) is installed in the INU server ⇒ [70](#).
1. Start the INU Control Center.
  2. Select **SECURITY – Authentication**.
  3. Select **TTLS** from the **Authentication method** list.
  4. Enter the user name and the password of the user account that is set up for the INU server on the RADIUS server.
  5. Select the settings which secure the communication in the TLS channel.
  6. Increase the security during connection establishment (optional):  
From the list **EAP root certificate**, select the root CA certificate.
  7. Click **Save & Restart** to confirm.
- ↳ The settings will be saved.

## Configuring PEAP

With PEAP (Protected Extensible Authentication Protocol), an encrypted TLS (Transport Layer Security) tunnel is established between the INU server and the RADIUS server. To do this, the RADIUS server authenticates itself to the INU server using a certificate that was signed by a CA. The TLS channel is then used to establish another connection that can be protected by means of additional EAP authentication methods (e.g. MSCHAPv2).

The method is very similar to EAP-TTLS (⇒ [73](#)), but other methods are used to authenticate the INU server.

- ✓ A user account for the INU server is set up on the RADIUS server.
  - ✓ For increased security during connection establishment (optional): The root CA certificate of the certification authority that has issued the certificate of the authentication server (RADIUS) is installed in the INU server ⇒ [70](#).
1. Start the INU Control Center.
  2. Select **SECURITY – Authentication**.
  3. Select **PEAP** from the **Authentication method** list.
  4. Enter the user name and the password of the user account that is set up for the INU server on the RADIUS server.
  5. Select the settings which secure the communication in the TLS channel.
  6. Increase the security during connection establishment (optional):  
From the list **EAP root certificate**, select the root CA certificate.
  7. Click **Save & Restart** to confirm.
- ↳ The settings will be saved.

### Configuring EAP-FAST

EAP-FAST (Flexible Authentication via Secure Tunneling) is a specific EAP method developed by the company Cisco. As with EAP-TTLS (⇒ 73) and PEAP (⇒ 73) a secure tunnel protects data transmission. However, the server does not authenticate itself with a certificate. Instead it uses PACs (Protected Access Credentials).

- ✓ A user account for the INU server is set up on the RADIUS server.
- 1. Start the INU Control Center.
- 2. Select **SECURITY – Authentication**.
- 3. Select **FAST** from the **Authentication method** list.
- 4. Enter the user name and the password of the user account that is set up for the INU server on the RADIUS server.
- 5. Select the settings intended to secure the communication in the channel.
- 6. Click **Save & Restart** to confirm.
  - ↳ The settings will be saved.

## 7 Maintenance

You can maintain the INU server in the following ways:

- How to Restart the INU Server ⇒ 76
- How to Update ⇒ 77
- How to Backup Your Configuration ⇒ 78
- How to Reset Parameters to their Default Values ⇒ 80

## 7.1 How to Restart the INU Server

After some parameter changes or after an update, the INU server restarts automatically. If the INU server is in an undefined state, you can also restart the INU server manually.

- Restarting the INU Server via the INU Control Center ⇨ 76

### Restarting the INU Server via the INU Control Center

1. Start the INU Control Center.
  2. Select **MAINTENANCE – Restart**.
  3. Click **Restart**.
- ↳ The INU server restarts.



## 7.2 How to Update

You can update your INU server with a soft- and firmware update. New firmware/software contains new features and/or error fixes.

You can find the version number of the firmware/software installed on the INU server on the start page of the INU Control Center.

For current firmware/software files go to the SEH Computertechnik GmbH website:

<https://www.seh-technology.com/us/services/downloads.html>



Only the existing firmware/software is updated; settings will be preserved.

**Important:**

Every update file comes with a 'readme' file. Read the 'readme' file and follow its instructions.

1. Start the INU Control Center.
  2. Select **MAINTENANCE – Update**.
  3. Specify the update file in the **Update file** box.
  4. Click **Install**.
- ↳ The update is executed. Afterwards, the INU server restarts.

## 7.3 How to Backup Your Configuration

All settings of the INU server (exception: passwords) are saved in the file '<Default-Name>\_parameters.txt'.

You can save this parameters file as backup copy to your local client. This way you can return to a stable configuration status at any time.

You can edit the parameter values in the backed up file using a text editor. Afterwards, the edited file can be loaded onto one or more INU servers. The device(s) will then adopt the parameter values of the file.

You can find a detailed description of the parameters in the Parameter Lists ⇒ [85](#).

The INU-Server also has an automatic backup feature. It saves the parameter values, passwords and certificates installed on the INU server automatically to a connected SD card. After a parameter or certificate change, the backup will be updated automatically. To transfer the settings to another INU server, you simply insert the SD card into the other device. After a cold boot (interruption and re-establishment of the power supply), the settings will be loaded automatically.



### WARNING

If the SD card is lost or stolen, your environment becomes vulnerable (certificates, passwords).

Therefore, you have to take all necessary precautions to protect the INUserver if you use the automatic backup.

- See Parameter Values ⇒ [78](#)
- Saving the Parameter File ⇒ [78](#)
- Loading the Parameters File onto a INU Server ⇒ [78](#)
- Automatic Backup ⇒ [79](#)

### See Parameter Values

1. Start the INU Control Center.
  2. Select **MAINTENANCE – Parameter backup**.
  3. Click the icon .
- ↳ The current parameter values are displayed.

### Saving the Parameter File

1. Start the INU Control Center.
  2. Select **MAINTENANCE – Parameter backup**.
  3. Click the icon .
  4. Save the '<default name>\_parameters.txt' file to a local system using your browser.
- ↳ The parameters file is backed up.

### Loading the Parameters File onto a INU Server

1. Start the INU Control Center.
  2. Select **MAINTENANCE – Parameter backup**.
  3. In the **Parameter file** box, specify the '<default name>\_parameters.txt' file.
  4. Click **Import**.
- ↳ The INU server adopts the parameter values from the file.

### Automatic Backup

- ✓ An SD card is connected to the INU server.
- ✓ The SD card has the file system FAT12, FAT16 or FAT32.
- ✓ 1 MB of free space is available on the SD card.

(These requirements are fulfilled ex factory).

1. Start the INU Control Center.
  2. Select **MAINTENANCE – SD card**.
  3. Tick **Parameter backup**.
  4. Click **Save**.
- ↳ The settings will be saved.

## 7.4 How to Reset Parameters to their Default Values

You can reset the INU to its default values, e.g. if you want to install the INU server in a different network. All settings will be set to factory settings. Installed certificates will not be deleted.



### Important:

The connection to the INU Control Center may be interrupted if the IP address of the INU server changes with the reset.

If required, determine the new IP address ⇒ [721](#).

You can change the settings either via remote access (INU Control Center) or via the reset button on the INU server.



*If you lost the password for the INU Control Center, you can reset the INU server via the reset button. You do not need a password to do so.*



### WARNING

Remove the SD card from the INU server before resetting the parameters. Otherwise, the INU server will adopt the parameter values stored on it (automatic backup ⇒ [778](#)).

- Resetting Parameters via INU Control Center ⇒ [80](#)
- Resetting Parameters via Reset Button ⇒ [80](#)

### Resetting Parameters via INU Control Center

1. Start the INU Control Center.
2. Select **MAINTENANCE – Default settings**.
3. Click **Default settings**.  
A security query appears.
4. Confirm the security query.  
↳ The parameters are reset.

### Resetting Parameters via Reset Button

With the reset button you can reset the INU server's parameter values to their default settings.

1. Press the reset button for 5 seconds.  
The INU server restarts.  
↳ The parameters are reset.

## 8 Appendix

The appendix contains a glossary, a troubleshooting guide and the lists of this document.

- Glossary ⇒ 81
- Parameter Lists ⇒ 85
- SEH UTN Manager – Feature Overview ⇒ 105
- Index ⇒ 107

### Glossary

#### Compound USB device

A compound USB device consists of a hub and one or more USB devices that are all integrated into a single housing. Dongles are often compound USB devices.

If a compound USB device is connected to a USB port of the INU server, all integrated USB devices will be shown in the INU Control Center and in the selection list of the SEH UTN Manager. When the port connection is activated, all displayed USB devices will be connected to the user's client. It is not possible to activate a port connection to only one of the USB devices.

#### Default name

Device name which is assigned by the manufacturer and cannot be changed. If you are using several identical INU servers, you can identify a certain device with it.

The default name of the INU server is made up of the two letters 'IC' and the device number. The device number consists of the last six numbers of the hardware address.

You can see the default name in the INU Control Center.

#### Hardware address

The hardware address (often also referred to as Ethernet address, physical address or MAC address) is the world-wide unique identifier of a network interface. If you are using several identical INU servers, you can identify a certain device with it.

The manufacturer has defines the address in the hardware of the device. It consists of 12 hexadecimal numbers. The first six numbers represent the manufacturer, while the last six numbers identify the individual device. The characters for separating the numbers depend on the platform. In Linux ':' are used.

Hardware address

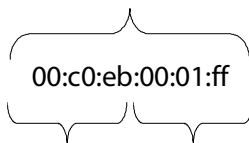

Manufacturer ID Device number

You can see the hardware address on the housing or in the SEH UTN Manager.

#### INU Control Center

The INU Control Center is the user interface of the INU server. The INU server can be configured and monitored via the INU Control Center.

You access the INU Control Center with an Internet browser (e.g. Mozilla Firefox).

More information ⇒ 9.

## 8.1 Troubleshooting

In this chapter, a few problems are described, explained and fixed.

### Problem

- INU Server: BIOS Mode ⇒ 82
- INU Server: Connection Cannot Be Established ⇒ 82
- INU Control Center: Connection Cannot Be Established ⇒ 83
- INU Control Center: You Lost User Name and/or Password ⇒ 83
- SEH UTN Manager: A Connection to the USB device Cannot Be Established ⇒ 83
- SEH UTN Manager: USB Devices Are Not Shown ⇒ 83
- SEH UTN Manager: A USB Device Is Connected to the USB Port, but several USB Devices Are Displayed ⇒ 84
- SEH UTN Manager: Features Are Not Available or Deactivated ⇒ 84

### Fix

#### INU Server: BIOS Mode

The INU server switches to the BIOS mode if the firmware works but the software is faulty. This may happen in the case of an incorrect software update, for example.



*The LEDs indicate the BIOS mode:*

- Status LED is off
- Activity LED blinks periodically



### **WARNING**

The INU server is not operational if it is in BIOS mode.  
Contact our support ⇒ 5.

#### INU Server: Connection Cannot Be Established

You find the INU server in the network and can reach it via TCP/IP connection. However, a connection via the SEH UTN Manager cannot be established.

Possible causes:

- A firewall or some other security software blocks communication.  
Add the UTN port respectively UTN SSL port as exception to your firewall or security software. Refer to the documentation of your firewall or security software on how to do this.
- The port numbers in the SEH UTN Manager and on the INU server are not identical: You changed the port number while SNMPv1 is deactivated, so that the change cannot be communicated to the SEH UTN Manager ⇒ 26.

INU Control Center: Connection Cannot Be Established

Eliminate possible error sources. Check:

- the cabling connections,
- the IP address of the INU server ⇒ 21
- the proxy settings of your browser (refer to the documentation of your browser for more information)

If you still cannot establish any connection, the following safety mechanisms might be the cause:

- Access is protected via SSL/TLS (HTTPS) ⇒ 59.
- Access is protected via SSL/TLS (HTTPS) and you deleted the certificate (self-signed/CA/PKCS#12) ⇒ 67. Reset the INU server to its default parameter values ⇒ 80. In the process, new certificates will be created.

**WARNING**

If you reset the device, all settings are lost and the IP address might change.  
If required, determine the new IP address ⇒ 21.

- TCP port access control is enabled ⇒ 63.
- The cipher suites of the encryption level are not supported by the browser ⇒ 60.

INU Control Center: You Lost User Name and/or Password

If the access to the INU Control Center is protected but you have lost the access credentials, you can reset the INU server to its default values. After the reset you can access the INU Control Center again, as it is not protected by default.

**WARNING**

If you reset the device, all settings are lost and the IP address might change.  
If required, determine the new IP address ⇒ 21.

SEH UTN Manager: A Connection to the USB device Cannot Be Established

Possible causes:

- The USB port is already connected to another client.  
Wait until the other user terminates the connection or request the device ⇒ 46.
- The driver software for the USB device is not installed on the client.  
Install the driver software for your USB device. Refer to the documentation of your USB device on how to do this.

SEH UTN Manager: USB Devices Are Not Shown

Eliminate possible error sources: Check if the USB device is connected to the INU server.

If the USB device is still not displayed, the following issues might be the cause:

- Several compound USB devices (⇒ 81) are connected to the INU server. Each integrated USB device occupies a virtual USB port of the INU server. The number of these virtual USB ports is limited. If the limit is reached, no further USB devices can be used on this INU server (⇒ 44).
- The USB port is deactivated ⇒ 36.
- The USB port key control is activated for the USB device ⇒ 64.  
Only once the key for the USB port is entered in the SEH UTN Manager, the USB port and the connected USB device appear.

SEH UTN Manager: A USB Device Is Connected to the USB Port, but several USB Devices Are Displayed

Possible causes:

- A USB hub IH-304 is connected to the USB port of the INU server.
- The connected USB device is a compound USB device (⇒ ¶81). It consists of a hub and one or more USB devices that are all integrated into a single housing. When the connection to the USB port is established, all displayed USB devices will be connected to the user's client and can be used.

SEH UTN Manager: Features Are Not Available or Deactivated

Possible causes:

- Your client user account does not have the required administrative rights. This restricts user rights in the SEH UTN Manager as well. More details can be found in chapter 'SEH UTN Manager – Feature Overview' ⇒ ¶105. Start the SEH UTN Manager as administrator. Refer to the documentation of your operating system on how to do this.
- A function is not supported by the connected USB device.



## 8.2 Parameter Lists

The INU servers stores its configuration as parameters. You directly use parameters for:

- Administration via email ⇒ 118
- Configuration backup (viewing, editing and loading parameters onto other devices) ⇒ 178

The following tables list all parameters and their values so that you can use them in the actions named above.

- Table 14 'Parameter list – IPv4' ⇒ 86
- Table 15 'Parameter list – IPv6' ⇒ 87
- Table 16 'Parameter list – DNS' ⇒ 87
- Table 17 'Parameter list – SNMP' ⇒ 88
- Table 18 'Parameter list – Bonjour' ⇒ 89
- Table 19 'Parameter list – POP3' ⇒ 89
- Table 20 'Parameter list – SMTP' ⇒ 90
- Table 21 'Parameter list – IPv4-VLAN' ⇒ 92
- Table 22 'Parameter list – Date/Time' ⇒ 93
- Table 23 'Parameter list – Description' ⇒ 93
- Table 24 'Parameter list – USB port' ⇒ 94
- Table 25 'Parameter list – UTN port' ⇒ 94
- Table 26 'Parameter list – Notification' ⇒ 95
- Table 27 'Parameter list – SSL/TLS connections' ⇒ 98
- Table 28 'Parameter list – INU Control Center security' ⇒ 99
- Table 29 'Parameter list – TCP port access' ⇒ 101
- Table 30 'Parameter list – USB connection encryption' ⇒ 102
- Table 31 'Parameter list – USB device type blocking' ⇒ 102
- Table 32 'Parameter list – IPv4-VLAN' ⇒ 102
- Table 33 'Parameter list – Authentication' ⇒ 103
- Table 34 'Parameter list – Backup' ⇒ 104
- Table 35 'Parameter list – Miscellaneous' ⇒ 104

Table 14: Parameter list – IPv4

Parameters	Value	Default	Description
ip_addr [IP address]	valid IP address	169.254.0.0/ 16	IP address of the INU server.
ip_mask [Subnet mask]	valid IP address	255.255.0.0	Subnet mask of the INU server. Subnet masks are used to logically partition big networks into subnetworks. If you are using the INU server in a subnetwork, it requires the subnet mask of the subnetwork.
ip_gate [Gateway]	valid IP address	0.0.0.0	IP address of the network's standard gateway which the INU server uses. With a gateway, you can address IP addresses from other networks.
ip_dhcp [DHCP]	on/off	on	Enables/disables the DHCP protocol. If DHCP is enabled in your network, IP address assignment is automatic.
ip_bootp [BOOTP]	on/off	on	Enables/disables the BOOTP protocol. If BOOTP is enabled in your network, IP address assignment is automatic.
ip_auto [ARP/PING]	on/off	on	Enables/disables the ARP/PING protocol. You can use the commands ARP and PING to change an IP address which was assigned via Zeroconf. The implementation depends on your system; read the documentation of your operating system.



*We recommend that you deactivate **DHCP**, **BOOTP** and **ARP/PING** as soon as the INU server has received its IP address.*

Table 15: Parameter list – IPv6

Parameters	Value	Default	Description
ipv6 [IPv6]	on/off	on	Enables/disables the IPv6 functionality of the INU server.
ipv6_auto [Automatic configuration]	on/off	on	Enables/disables the automatic assignment of the IPv6 address to the INU server.
ipv6_addr [IPv6 address]	n:n:n:n:n:n	::	<p>Defines an IPv6 unicast address in the format n:n:n:n:n:n which is manually assigned to the INU server.</p> <ul style="list-style-type: none"> <li>• Every 'n' represents the hexadecimal value of one of the eight 16 bit elements of the address.</li> <li>• Leading zeros can be omitted.</li> <li>• An IPv6 address may be entered or displayed using a shortened version when successive fields contain all zeros (0). In this case, two colons (::) are used.</li> </ul>
ipv6_gate [Router]	n:n:n:n:n:n	::	Manually defines a static router to which the INU server sends its requests.
ipv6_plen [Prefix length]	0–64 [1–2 characters; 0–9]	64	<p>Defines the length of the subnet prefix for the IPv6 address. The value 64 is preset.</p> <p>Address ranges (e.g. your network) are specified with prefixes. To do this, the prefix length (number of bits used) is added to the IPv6 address as a decimal number and the decimal number is preceded by '/'.</p>

Table 16: Parameter list – DNS

Parameters	Value	Default	Description
dns [DNS]	on/off	on	Enables/disables the name resolution via a DNS server.
dns_domain [Domain name]	max. 255 characters [a–z, A–Z, 0–9]	[blank]	Defines the IP address of the primary DNS server.
dns_primary [Primary DNS server]	valid IP address	0.0.0.0	<p>Defines the IP address of the secondary DNS server.</p> <p>The secondary DNS server is used if the first one is not available.</p>
dns_secondary [Secondary DNS server]	valid IP address	0.0.0.0	Defines the domain name of an existing DNS server.

Table 17: Parameter list – SNMP

Parameters	Value	Default	Description
snmpv1 [SNMPv1]	on/off	on	Enables/disables SNMPv1.
snmpv1_ronly [Read-only]	on/off	off	Enables/disables the write protection for the community.
snmpv1_community [Community]	max. 64 characters [a-z, A-Z, 0-9]	public	SNMP community name Enter the name as it is defined in the monitoring station.
<div style="display: flex; align-items: center;">  <div> <p><b>Important:</b></p> <p>The default name is 'public'. This name is commonly used for read/write communities. We recommend to change it as soon as possible to increase security.</p> </div> </div>			
snmpv3 [SNMPv3]	on/off	on	Enables/disables SNMPv3.
any_hash [Hash]	md5 sha	md5	Specifies the hash algorithm for SNMP user group 1.
any_rights [Access rights]	--- readonly readwrite	readonly	Defines the access rights of the SNMP user group 1. --- = [none]
any_cipher [Encryption]	--- aes des	---	Defines the encryption method of the SNMP user group 1. --- = [none]
admin_hash [Hash]	md5 sha	md5	Specifies the hash algorithm for SNMP user group 2.
admin_rights [Access rights]	--- readonly readwrite	readwrite	Defines the access rights of the SNMP user group 2. --- = [none]
admin_cipher [Encryption]	--- aes des	---	Defines the encryption method of the SNMP user group 2.



**Important:**

The INU server user accounts are also used as SNMP user accounts ⇨ 26. Consider this when setting up user accounts.

Table 18: Parameter list – Bonjour

Parameters	Value	Default	Description
bonjour [Bonjour]	on/off	on	Enables/disables Bonjour.
bonjour_name [Bonjour name]	max. 64 characters [a–z, A–Z, 0–9]	[Default name]	Defines the Bonjour name of the INU server. The INU server uses this name to announce its Bonjour services. If no Bonjour name is entered, a default name will be used (device name@lCxxxxxx).

Table 19: Parameter list – POP3

Parameters	Value	Default	Description
pop3 [POP3]	on/off	off	Enables/disables the POP3 functionality.
pop3_srv [Server name]	max. 128 characters	[blank]	Defines the POP3 server via its IP address or host name. A host name can only be used if a DNS server was configured beforehand.
pop3_port [Server port]	1–65535 [1–5 characters; 0–9]	110	Defines the port which the INU server uses to receive emails. The default port number for POP3 is 110. The default port number for SSL/TLS (parameter 'pop3_sec' ⇒ 89) is 995. If required, read the documentation of your POP3 server.
pop3_sec [Security]	0–2 [1 character; 0–2]	0	Defines the authentication method to be used: <ul style="list-style-type: none"> <li>APOP: encrypts the password when logging on to the POP3 server.</li> <li>SSL/TLS: encrypts the entire communication with the POP3 server. The encryption strength is defined via the encryption protocol and level ⇒ 60.</li> </ul> 0 = no security 1 = APOP 2 = SSL/TLS
pop3_poll [Check mail every]	1–10080 [1–5 characters; 0–9]	2	Defines the time interval (in minutes) which with the POP3 server is checked for emails.
pop3_limit [Ignore mail exceeding]	0–4096 [1–4 characters; 0–9]	4096	Defines the maximum email size (in Kbyte) to be accepted by the INU server. 0 = unlimited
pop3_usr [User name]	max. 128 characters	[blank]	Defines the user name used by the INU server to log on to the POP3 server.
pop3_pwd [Password]	max. 128 characters	[blank]	Defines the user password used by the INU server to log on to the POP3 server.

Table 20: Parameter list – SMTP

Parameters	Value	Default	Description
smtp_srv [Server name]	max. 128 characters	[blank]	Defines the SMTP server via the IP address or the host name.  A host name can only be used if a DNS server was configured beforehand.
smtp_port [Server port]	1–65535 [1–5 characters; 0–9]	25	Defines the port which the INU server and SMTP server use to communicate.  The default port number for SMTP is 25. For SSL/TLS (parameter 'smtp_ssl' ⇒ 90), SMTP servers use by default port 587 (STARTSSL/STARTTLS) or the old port 465 (SMTPS). If required, read the documentation of your SMTP server.
smtp_ssl [SSL/TLS]	on/off	off	Enables/disables SSL/TLS.  SSL/TLS encrypts the communication from the INU to the SMTP server. The encryption strength is defined via the encryption protocol and level ⇒ 60.
smtp_sender [Sender name]	max. 128 characters	[blank]	Defines the email address used by the INU server to send emails.  Very often the name of the sender and the email account user name are identical.
smtp_auth [Login]	on/off	off	Enables/disables SMTP authentication (SMTP AUTH). To send emails, the INU sends its user name and password to the SMTP server to authenticate itself. Enter user name (parameter 'smtp_usr' ⇒ 90) and password (parameter 'smtp_pwd' ⇒ 90).  Some SMTP servers require SMTP authentication to prevent fraudulent use (spam).
smtp_usr [User name]	max. 128 characters	[blank]	Defines the user name used by the INU server to log on to the SMTP server.
smtp_pwd [Password]	max. 128 characters	[blank]	Defines the password used by the INU server to log on to the SMTP server.
smtp_sign [Security (S/MIME)]	on/off	off	Enables/disables the email security standard S/MIME (Secure/Multipurpose Internet Mail Extensions). S/MIME is used to sign (parameter 'smtp_sign' ⇒ 90) or encrypt (parameter 'smtp_encrypt' ⇒ 91) emails. Enable the desired feature (if desired with 'smtp_attpkey' ⇒ 90).
smtp_attpkey [Attach public key]	on/off	on	Sends the public key together with the email.  Many email clients require the key to display the email.

Parameters	Value	Default	Description
smtp_encrypt [Full encryption] [Signing emails]	on/off	off	<p>on = Activates the encryption of emails. Only the intended recipient can open and read the encrypted email. An S/MIME certificate is required for the encryption ⇒ 67.</p> <p>off = Activates the signing of emails. The recipient can use the signature to check the sender's identity. This proves, that the email has not been altered. An S/MIME certificate is required for the signing of emails ⇒ 67.</p>

Table 21: Parameter list – IPv4-VLAN

Parameters	Value	Default	Description
ip4vlan_mgmt [IPv4 management VLAN]	on/off	off	Enables/disables the forwarding of IPv4 management VLAN data. If this option is enabled, SNMP is only available in the IPv4 management VLAN.
ip4vlan_mgmt_id [VLAN-ID]	0–4096 [1–4 characters; 0–9]	0	ID for the identification of the IPv4 management VLAN.
ip4vlan_mgmt_any [Access from any VLAN]	on/off	off	Enables/disables the administrative access (web) to the INU server via IPv4 client VLANs. If this option is enabled, the INU server can be administrated via all VLANs.
ip4vlan_mgmt_untag [Access via LAN (untagged)]	on/off	on	Enables/disables the administrative access to the INU server via IPv4 packets without tag. If this option is disabled, the INU server can only be administrated via VLANs.
ipv4vlan_on_1 ~ ipv4vlan_on_20 [VLAN]	on/off	off	Enables/disables the forwarding of IPv4 client VLAN data.
ipv4vlan_addr_1 ~ ipv4vlan_addr_20 [IP address]	valid IP address	192.168.0.0	IP address of the INU server within the IPv4 client VLAN.
ipv4vlan_mask_1 ~ ipv4vlan_mask_20 [Subnet mask]	valid IP address	255.255.255.0	Subnet mask of the INU server within the IPv4 client VLAN.
ip4vlan_gate_1 ~ ip4vlan_gate_20 [Gateway]	valid IP address	0.0.0.0	IP gateway address in the IPv4 management VLAN. With a gateway, you can address IP addresses from other networks.
ipv4vlan_id_1 ~ ipv4vlan_id_20 [VLAN-ID]	0–4096 [1–4 characters; 0–9]	0	ID for the identification of the IPv4 client VLAN.
utn_2vlan_1 ~ utn_2vlan_20 [Allocate VLAN]	0–9 [1 character; 0–9]	0	Allocates a VLAN to the USB port. 0 = every 1 = VLAN 1 2 = VLAN 2 etc. 9 = none



Table 22: Parameter list – Date/Time

Parameters	Value	Default	Description
ntp [Date/Time]	on/off	on	Enables/disables the use of a time server (SNTP).
ntp_server [Time server]	max. 64 characters [a-z, A-Z, 0-9]	pool.ntp.org	<p>Defines a time server via the IP address or the host name.</p> <p>The host name can only be used if a DNS server was configured beforehand.</p> <div style="border-left: 2px solid #0070C0; padding-left: 10px; margin-top: 10px;">  <p><b>Important:</b> If your network is configured accordingly, the INU server receives the time server settings automatically via DHCP. A time server assigned in such a manner always takes precedence over manual settings.</p> </div>
ntp_tzone [Time zone]	UTC, GMT, EST, EDT, CST, CDT, MST, MDT, PST, PDT, etc.	CET/CEST (EU)	Compensates Coordinated Universal Time (UTC) for location and national particularities (day-light saving time etc.).

Table 23: Parameter list – Description

Parameters	Value	Default	Description
sys_name [Host name]	max. 64 characters [a-z, A-Z, 0-9]	[blank]	<p>Device name as alternative to IP address. With a name you can identify the INU server more easily in the network, e.g. if you are using several INU servers.</p> <p>Is displayed in the INU Control Center and SEH UTN Manager.</p>
sys_descr [Description]	max. 64 characters [a-z, A-Z, 0-9]	[blank]	<p>Device description, e.g. location or department.</p> <p>Is displayed in the INU Control Center and SEH UTN Manager.</p>
sys_contact [Contact person]	max. 64 characters [a-z, A-Z, 0-9]	[blank]	<p>Contact person, e.g. device administrator.</p> <p>Is displayed in the INU Control Center.</p>

Table 24: Parameter list – USB port

Parameters	Value	Default	Description
utn_tag_1 ~ utn_tag_20 [Port name]	max. 32 characters [a–z, A–Z, 0–9]	[blank]	Freely definable name of the USB port.
utn_poff_1 ~ utn_poff_20 [Port]	on/off	off	Disables/enables the power supply for the USB port (i.e. the USB device connected to the port). off = power on on = power off

Table 25: Parameter list – UTN port



Parameters	Value	Default	Description
utn_port [UTN port]	1–9200 [1–4 characters; 0–9]	9200	Defines the number of the UTN port (for unencrypted connections).   <b>WARNING</b> The UTN port must not be blocked by security software (firewall).
utn_sslport [UTN SSL port]	1–9443 [1–4 characters; 0–9]	9443	Defines the number of the UTN SSL port (for encrypted connections).   <b>WARNING</b> The UTN SSL port must not be blocked by security software (firewall).

Table 26: Parameter list – Notification

Parameters	Value	Default	Description
mailto_1 mailto_2 [Email address]	valid email address [max. 64 characters]	[blank]	Email address of the recipient for notifications.
noti_stat_1 noti_stat_2 [Status email]	on/off	off	Enables/disables the periodical sending of a status email to recipient 1 or 2.
notistat_d [Interval]	al su mo tu we th fr sa	al	Defines the day (the interval) on which a status email is sent. al = daily su = Sunday mo = Monday tu = Tuesday we = Wednesday th = Thursday fr = Friday sa = Saturday
notistat_h [hh]	0–23 [1–2 characters; 0–9]	0	Specifies the time (hour) at which a status email is sent. 1 = 1. hour 2 = 2. hour 3 = 3. hour etc.
notistat_tm [mm]	0–5 [1 character; 0–5]	0	Specifies the time (minute) at which a status email is sent. 0 = 00 min 1 = 10 min 2 = 20 min 3 = 30 min 4 = 40 min 5 = 50 min
noti_dev_1 noti_dev_2 [Send email if USB devices are connected or disconnected]	on/off	off	Enables/disables the sending of emails after a USB device was connected to/removed from the INU server.
noti_act_1 noti_act_2 [Send email if USB port is activated or deactivated]	on/off	off	Enables/disables the sending of emails after a USB port (i.e. the connection to the connected USB device) was activated/deactivated.





Parameters	Value	Default	Description
noti_pup_1 noti_pup_2 [Send email if INU server is restarted]	on/off	off	Enables/disables the sending of emails when the INU server restarts.
noti_pwr_1 noti_pwr_2 [Send email if power supply is interrupted or established]	on/off	off	Enables/disables the sending of emails when one of the two power supplies of the INU server is interrupted or established.
noti_lnk_1 noti_lnk_2 [Send email if network connection is interrupted or established]	on/off	off	Enables/disables the sending of emails when one of the two network connection of the INU server is interrupted or established.
noti_sdinout_1 noti_sdinout_2 [Send email if SD card is connected or disconnected]	on/off	off	Enables/disables the sending of emails after an SD card was connected to/removed from the INU server.
noti_sdunusable_1 noti_sdunusable_2 [Send email if SD card cannot be used]	on/off	off	Enables/disables the sending of emails if the SD card is unusable.
trapto_1 trapto_2 [Address]	valid IP address	0.0.0.0	SNMP trap address of the recipient.
trapcommu_1 trapcommu_2 [Community]	max. 64 characters [a-z, A-Z, 0-9]	public	SNMP trap community of the recipient.
trapdev [Send trap if USB devices are connected or disconnected]	on/off	off	Enables/disables the sending of SNMP traps after a USB device was connected to/removed from the INU server.
trapact [Send trap if USB ports are activated or deactivated]	on/off	off	Enables/disables the sending of SNMP traps after a USB port (i.e. the connection to the connected USB device) was activated/deactivated.
trappup [Send trap if INU server is restarted]	on/off	off	Enables/disables the sending of SNMP traps when the INU server is restarted.

Parameters	Value	Default	Description
trap_pwr [Send trap if power supply is interrupted or established]	on/off	off	Enables/disables the sending of SNMP traps when one of the two power supplies of the INU server is interrupted or established.
trap_lnk [Send trap if network connection is interrupted or established]	on/off	off	Enables/disables the sending of SNMP traps when one of the two network connections of the INU server is interrupted or established.
trap_sdinout [Send trap if SD card is connected or disconnected]	on/off	off	Enables/disables the sending of SNMP traps after an SD card was connected to/removed from the INU server.
trap_sdunusable [Send trap if SD card cannot be used]	on/off	off	Enables/disables the sending of SNMP traps if the SD card is unusable.

Table 27: Parameter list – SSL/TLS connections

Parameters	Value	Default	Description
sslmethod [Encryption protocol]	any sslv3 tls10 tls11 tls12	any	<p>Defines the encryption protocol for SSL/TLS connections.</p> <p>any = at will (automatic negotiation)</p> <p>sslv3 = SSL 3.0</p> <p>tls10 = TLS 1.0</p> <p>tls11 = TLS 1.1</p> <p>tls12 = TLS 1.2</p> <div style="border-left: 2px solid red; padding-left: 10px; margin-top: 10px;"> <p><b>WARNING</b></p> <p>Current browsers do not support low security settings. If you use SSL with a current browser and the setting <b>HTTPS only</b> for access to the INU Control Center (⇒ 59), a connection cannot be established.</p> <p>Use TLS (and <u>not</u> SSL).</p> </div>
security [Encryption level]	1–4 [1 character; 1–4]	4	<p>Defines the encryption level for SSL/TLS connections.</p> <p>1 = low</p> <p>2 = medium</p> <p>3 = high</p> <p>4 = any (automatic negotiation)</p> <div style="border-left: 2px solid red; padding-left: 10px; margin-top: 10px;"> <p><b>WARNING</b></p> <p>Current browsers do not support cipher suites from the <b>Low</b> level. If you use <b>Low</b> with a current browser and the setting <b>HTTPS only</b> for access to the INU Control Center (⇒ 59), a connection cannot be established.</p> <p>Use an encryption level as high as possible.</p> </div> <div style="border-left: 2px solid red; padding-left: 10px; margin-top: 10px;"> <p><b>WARNING</b></p> <p>The SEH UTN Manager does not support the encryption level <b>Low</b>. If you set up <b>Low</b> in combination with an encrypted USB connection, a connection cannot be established.</p> <p>Use an encryption level as high as possible.</p> </div>

Table 28: Parameter list – INU Control Center security

Parameters	Value	Default	Description
http_allowed [Connection]	on/off	on	<p>Defines the connection type (HTTP/HTTPS) to be used for connecting to the INU Control Center.</p> <p>on = HTTP/HTTPS off = HTTPS only</p> <p>The encryption strength is defined via the encryption protocol and level ⇨ 60.</p> <div style="border-left: 2px solid red; padding-left: 10px;"> <p><b>WARNING</b></p> <p> Current browsers do not support low security settings. With them a connection cannot be established. Do <u>not</u> use the following combination: Encryption protocol <b>HTTPS</b> and encryption level <b>Low</b>.</p> <p>When the connection is established, the identity of the INU server is verified. For that, the client asks for the certificate via the browser (⇨ 67). This certificate must be accepted by the browser; read the documentation of your browser software.</p> </div>
sessKeys [Restrict Control Center access]	on/off	off	<p>Enables/disables the INU Control Center user accounts. If they are enabled, a login screen is displayed when opening the INU Control Center.</p> <div style="border-left: 2px solid blue; padding-left: 10px;"> <p><b>Important:</b></p> <p> Define user accounts (user names and passwords).</p> </div>
admin_name [Administrator – User name]	max. 64 characters [a–z, A–Z, 0–9]	admin	<p>Defines the user name for the administrator user account.</p> <div style="border-left: 2px solid blue; padding-left: 10px;"> <p><b>Important:</b></p> <p> Also is the user name of the SNMPv3 admin account ⇨ 26.</p> </div>
admin_pwd [Administrator – Password]	8–64 characters [a–z, A–Z, 0–9]	administrator	<p>Defines the password for the administrator user account.</p> <div style="border-left: 2px solid blue; padding-left: 10px;"> <p><b>Important:</b></p> <p> Also is the password of the SNMPv3 admin account ⇨ 26.</p> </div>
any_name [Read-only user – User name]	max. 64 characters [a–z, A–Z, 0–9]	anonymous	<p>Defines the user name for the read-only user account.</p> <div style="border-left: 2px solid blue; padding-left: 10px;"> <p><b>Important:</b></p> <p> Also is the user name of the SNMPv3 user account ⇨ 26.</p> </div>

Parameters	Value	Default	Description
any_pwd [Read-only user – Password]	max. 64 characters [a–z, A–Z, 0–9]	[blank]	Defines the password for the read-only user account.   <b>Important:</b> Also is the password of the SNMPv3 user account ⇔ 26.
sessKeyUList [Login screen displays]	on/off	on	Defines the type of login screen. on= Shows a user list, only password must be entered off= neutral login mask, user name and password must be entered
sessKeyTimer [Session timeout]	on/off	on	Enables/disables the session timeout.
sessKeyTimeout [Session timeout]	120–3600 [3–4 characters; 0–9]	600	Time in seconds after which the timeout is to be effective.



Table 29: Parameter list – TCP port access



Parameters	Value	Default	Description
protection [Port access control]	on/off	off	Enables/disables the blocking of selected ports and thus connections to the INU server.
protection_level [Security level]	protec_utn protec_tcp protec_all	protec_utn	Specifies the port types to be blocked: protec_utn = UTN access (UTN ports) protec_tcp = TCP access (TCP ports: HTTP/HTTPS/UTN) protec_all = all ports (IP ports)
ip_filter_on_1 ~ ip_filter_on_8 [IP address]	on/off	off	Enables/disables an exception from the port locking.
ip_filter_1 ~ ip_filter_8 [IP address]	valid IP address	[blank]	Defines networks elements that are excluded from port blocking via their IP address.   <b>Important:</b> The use of wildcards (*) allows you to define subnetworks.
hw_filter_on_1 ~ hw_filter_on_8 [MAC address]	on/off	off	Enables/disables an exception from the port locking.
hw_filter_1 ~ hw_filter_8 [MAC address]	valid hardware address	00:00:00:00:0 0:00	Defines elements that are excluded from port locking using the MAC address (hardware address).   <b>Important:</b> MAC addresses are not delivered through routers!
protection_test [Test mode]	on/off	on	Enables/disables the test mode.   <b>WARNING</b> The test mode is active by default so that you can test your settings without locking yourself out. Your settings will be active until the INU is restarted, afterwards access is no longer restricted. After you have successfully tested your settings, you have to deactivate the test mode so that access control is permanent.

Table 30: Parameter list – USB connection encryption

Parameters	Value	Default	Description
utn_sec_1 ~ utn_sec_20 [USB port]	on/off	off	Enables/disables the SSL/TLS encryption for the connection between USB port (i.e. USB device) and client.
			 <b>Important:</b> Only payload will be encrypted. Control and log data will be transmitted without encryption.

Table 31: Parameter list – USB device type blocking

Parameters	Value	Default	Description
utn_hid [Disable input devices (HID class)]	on/off	on	Enables/disables the blocking of input devices (HID – human interface devices). on = no blocking off = blocking

Table 32: Parameter list – IPv4-VLAN

Parameters	Value	Default	Description
utn_accctr_1 ~ utn_accctr_20 [Method]	--- ids key keyids	---	Defines the method(s) for limiting the access and use of the USB port and the connected USB device. --- = no protection ids = device assignment key = port key control keyids = device assignment and key control
utn_keyval_1 ~ utn_keyval_20 [Key]	max. 64 characters [a-z, A-Z, 0-9]	[blank]	Defines the key for the USB port and the connected USB device when port key control is used.
utn_vendprodIDs_1 ~ utn_vendprodIDs_20 [USB device]			Defines the VID (Vendor ID) and PID (Product ID) of the USB device that is assigned to the USB port via the device assignment.  <i>Often VID and PID of a USB device are unknown. We recommend configuration via the INU Control Center because VID and PID will be automatically determined and entered with this method.</i>



Table 33: Parameter list – Authentication

Parameters	Value	Default	Description
auth_typ [Authentication method]	--- MD5 TLS TTLS PEAP FAST	---	Defines the authentication method used in your network in which the INU server is to participate.  --- = none MD5 = EAP-MD5 TLS = EAP-TLS TTLS = EAP-TTLS PEAP = PEAP FAST = EAP-FAST
auth_name [User name]	max. 64 characters [a-z, A-Z, 0-9]	[blank]	Defines the user name with which the INU server is set up on the RADIUS server for the EAP authentication methods MD5, TTLS, PEAP, and FAST.
auth_pwd [Password]	max. 64 characters [a-z, A-Z, 0-9]	[blank]	Defines the password with which the INU server is set up on the RADIUS server for the EAP authentication methods MD5, TTLS, PEAP, and FAST.
auth_intern [Inner authentication]	--- PAP CHAP MSCHAP2 EMD5 ETLS	---	Defines the kind of inner authentication for the EAP authentication methods TTLS, PEAP, and FAST.  --- = none PAP = PAP CHAP = CHAP MSCHAP2 = MS-CHAPv2 EMD5 = EAP-MD5 ETLS = EAP-TLS
auth_extern [PEAP/EAP-FAST options]	--- PLABEL0 PLABEL PVER0 PVER1 FPROV1	---	Defines the kind of external authentication for the EAP authentication methods TTLS, PEAP, and FAST.  --- = none PLABEL0 = PEAPLABEL0 PLABEL1 = PEAPLABEL1 PVER0 = PEAPVER0 PVER1 = PEAPVER1 FPROV1 = FASTPROV1
auth_ano_name [Anonymous name]	max. 64 characters [a-z, A-Z, 0-9]	[blank]	Defines the anonymous name for the unencrypted part of the EAP authentication methods TTLS, PEAP, and FAST.
auth_wpa_addon [WPA Add on]	max. 255 characters [a-z, A-Z, 0-9]	[blank]	Defines an optional WPA expansion for the EAP authentication methods TTLS, PEAP, and FAST.

Table 34: Parameter list – Backup

Parameters	Value	Default	Description
autoSync [Parameter backup]	on/off	on	Enables/disables the automatic backup of parameter values, passwords, and certificates to a connected SD card.

Table 35: Parameter list – Miscellaneous

Parameters	Value	Default	Description
utn_heartbeat	1–1800 [1–4 characters; 0–9]	180	 <b>WARNING</b> This parameter can only be used after consultation with the SEH support team.
utn_poffdura_1 ~ utn_poffdura_20	0–100 [1–3 characters; 0–9]	0	 <b>WARNING</b> This parameter can only be used after consultation with the SEH support team.
utn_prereset_1 ~ utn_prereset_20	on/off	off	 <b>WARNING</b> This parameter can only be used after consultation with the SEH support team.

### 8.3 SEH UTN Manager – Feature Overview

Which features are inactive (greyed out) in the SEH UTN Manager depends on different factors:

- Selection list mode
  - global
  - user
- Client operating system (Windows, macOS, Linux)
- Client user account
  - administrator or group members of 'utnusers'
  - standard user or users which are not members of the group 'utnusers'
- Write access to the \*.ini file (selection list)



*The administrator can use these factors to provide users with individual functions.*

The following table gives an overview. It shows the features that are basically available. In addition, individual features will not be displayed or will be displayed as inactive because

- the USB device connected does not support them
- security measures have been implemented

Table 36: SEH UTN Manager – Feature Overview Linux

	Global Selection List		User Selection List		
	Adminis- trator	User	Adminis- trator	User (read/ write *.ini)	User (no read/ write *.ini)
<b>Menu</b>					
Selection List – Edit	✓	✗	✓	✓	✗
Selection List – Export	✓	✗	✓	✗	✗
Selection List – Refresh	✓	✓	✓	✓	✓
UTN Server – Configure	✓	✓	✓	✓	✓
UTN Server – Set IP Address	✓	✓	✓	✓	✓
UTN Server – Activate Auto-Connect	✓	✗	✓	✗	✗
USB Server – Set USB Port Keys	✓	✗	✓	✓	✗
UTN Server – Add	✓	✗	✓	✓	✗
UTN Server – Remove	✓	✗	✓	✓	✗
UTN Server – Refresh	✓	✓	✓	✓	✓
Port – Activate	✓	✓	✓	✓	✓
Port – Deactivate	✓	✓	✓	✓	✓
Port – Request	✓	✓	✓	✓	✓
Port – Remove	✓	✗	✓	✗	✗
Port – Settings	✓	✓	✓	✓	✓

	Global Selection List		User Selection List		
	Adminis- trator	User	Adminis- trator	User (read/ write *.ini)	User (no read/ write *.ini)
<b>Buttons</b>					
Selection List – Refresh	✓	✓	✓	✓	✓
Selection List – Edit	✓	x	✓	✓	x
Port – Activate	✓	✓	✓	✓	✓
Port – Deactivate	✓	✓	✓	✓	✓
<b>'Program – Options' dialog</b>					
Network Scan – Multicast Search	✓	x	✓	x	x
Network Scan – IP Range Search	✓	x	✓	x	x
Program – Program Messages	✓	x	✓	x	x
Program – Program Update	✓	x	✓	x	x
Automatisms – Auto-Disconnect	✓	x	✓	x	x
Selection List – Selection List Mode	✓	x	✓	x	x
Selection List – Automatic Refresh	✓	x	✓	x	x
<b>'Port Settings' dialog</b>					
Messages	✓	✓	✓	✓	✓

## 8.4 Index

### A

#### Administration

- email 18
- INU Control Center 9
- remote access 18
- SEH UTN Manager 11

#### Administrator 62

#### Authentication 72

#### Auto-Connect 47

#### Auto-Disconnect 47

#### Automatic backup 78

#### Automatic connection 47

#### Automatisms

- Auto-Connect 47
- Auto-Disconnect 47
- utnm 52

### B

#### Backup 78

- automatic 78

#### BadUSB 66

#### Bonjour 27

#### BOOTP (Bootstrap Protocol) 21

#### Brochures 4

#### Browser 9

#### Button 80

### C

#### CA (certification authority) 67

#### CA certificate 67

#### Certificate 67

- CA 67
- client 67
- create 68
- default 67
- delete 71
- management 67
- PKCS#12 67
- request 69
- requested 67
- S/MIME 67
- self-signed 67
- view 68

#### Certification authority 67

#### Cipher suite 60

#### Client certificate 67

#### Complete version 13

#### Compound USB device 44, 81

#### Configuration backup 78

#### Connection

- encryption 59
- INU Control Center 59

#### Console 52

#### Contact 5

#### Contact person 34

### D

#### Default certificate 67

#### Default name 81

#### Description 34

#### Device

- contact person 34
- description 34
- name 34, 81
- number 81
- time 33

#### Device number 81

#### DHCP (Dynamic Host Configuration Protocol) 21

#### DNS (Domain Name Service) 25

#### Documentation 4

- further applicable documents 4
- mark-ups 4
- symbols 4

#### Downloads 5

### E

#### EAP (Extensible Authentication Protocol) 72

- FAST (Flexible Authentication via Secure Tunneling) 74

#### MD5 (Message Digest #5) 72

- PEAP (Protected Extensible Authentication Protocol) 73

#### TLS (Transport Layer Security) 72

#### TTLS (Tunneled Transport Layer Security) 73

#### Email 38

- administration 18
- event 38
- notifications 38
- POP3 28
- SMTP 28

- status 38
- Encryption 57
  - cipher suite 60
  - email 60
  - HTTP 60
  - Level 60
  - POP3 60
  - protocol 60
  - SMTP 60
  - SSL/TLS 57
  - strength 60
  - USB connection 60
  - web access 60
- Ethernet address 81
- Event notification 38
- F**
- Factory default settings 80
- File '<Default-Name\_parameter.txt>' 78
- Firmware/software 77
- Further applicable documents 4
- G**
- Gateway 22
- Global Selection List 50
- Guarantee 6
- H**
- Hardware address 81
- Hardware Installation Guide 4
- HID (Human Interface Device) 66
  - blocking 66
- Host name 34, 93
  - Name resolution 25
- HTTP/HTTPS 59
- I**
- IEEE 802.1X 72
- Improper use 6
- ini-file 50
  - write access 50
- Intended use 6
- INU Control Center 9, 81
  - controls 10
  - encrypted connection 59
  - user accounts 62
- IP address
  - dynamic 21
  - IPv4 21
  - IPv6 23
  - static 21
- IP ports 63
- IPv4
  - gateway 22
  - subnet mask 22
- IPv6 23
  - prefix length 24
- L**
- Liability 6
- Licenses 4
- Login 62
- Login screen 62
- M**
- MAC address 81
- Maintenance 75
- Markups 4
- Minimal version 13
- Monitoring 26
- Multicast search 42
- N**
- Network list 42
- Notification service 38
- Notifications 38
- O**
- Online help 4
- Open source licenses 4
- P**
- Parameters 85
  - backup 78
  - default values 80
  - edit 78
  - file 78
  - lists 85
  - load 78
  - see 78
- Password 62
  - lost 80



- Physical address 81
- PKCS#12 certificate 67
- PKI (public key infrastructures) 67
- Point-to-point connection 44
- POP3 (Post Office Protocol Version 3) 28
- Port blocking 63
- Port connection 11, 41
  - activate 44
  - deactivate 45
- Prefix length 24
- Product information 4, 5
- Protection mechanisms 56
- Purpose 2
- Q**
- Quick Installation Guide 4
- R**
- Read-only user 62
- Release request 46
- Remote access 18
- Repairs 6
- Requested certificate 67
- Reset 80
  - button 80
  - remote access 80
- Reset button 80
- Restart 76
- S**
- S/MIME certificate 67
- Safety regulations 6
- Script 52
- SD card 78
  - automatic backup 78
  - transfer settings 78
- Security level 63
- Security mechanisms 56
- SEH UTN Manager 11, 41
  - complete version 13
  - feature overview 105
  - features 11
  - install 13
  - minimal version 13, 52
  - selection list 50
  - start 17
  - versions 13
  - without graphical user interface 52
- SEH UTN Service 13
- Selection list 42, 50
  - global 50
  - user 50
- Self-signed certificate 67
- Session timeout 62
- Settings
  - backup 78
  - transfer 78
- SMTP (Simple Mail Transfer Protocol) 28
- SNMP (Simple Network Management Protocol) 26
  - community 26
  - password 26
  - SNMPv1 26
  - SNMPv3 26
  - trap 38
  - user 26
- SNTP (Simple Network Time Protocol) 33
- SSL (Secure Sockets Layer) 57, 59, 60
- SSL/TLS connection 60
- Status email 38
- Subnet mask 22
- Symbols 4
- System requirements 2
- T**
- TCP access 63
- TCP port access control 63
  - exception 63
  - test mode 63
- Test mode 63
- Time server 33
- Time zone 33
- Timeout 62
- TLS (Transport Layer Security) 57, 59, 60
- Trap 38
- U**
- Update 77
- USB connection 37
  - automate 47
  - automatic 47

- automatic disconnect 47
  - disconnect 45
  - encryption 37, 44, 57
  - point-to-point 44
  - unencrypted 37
  - USB data transfer
    - encryption 57
  - USB device
    - access 64
    - automatic connection 47
    - automatic disconnect 47
    - automatisms 47
    - compound 44, 81
    - connect 41, 44
    - disconnect 45
    - find 42
    - HID (Human Interface Device) 66
    - notifications 49
    - release 46
    - request 46
    - status information 49
    - user access 50
  - USB device access 64
  - USB port 35, 36
    - access 64
    - activate 44
    - automatic connection 47
    - automatic disconnect 47
    - connect 44
    - deactivate 45
    - device assignment 64
    - disable 36
    - disconnect 45
    - enable 36
    - encryption 57
    - key control 64
    - name 35
    - notifications 49
    - power supply 36
    - status information 49
    - virtual 44
  - User account 62
    - administrator 62
    - password 62
    - read-only user 62
  - User name 62
  - User Selection List 50
  - UTC 33
  - UTN 37
    - access 63
    - port 37, 63
      - encrypt 37
      - SSL port 37
      - unencrypted 37
    - SSL port 57
  - utnm 52
    - commands 52
    - return value 54
    - syntax 52
- V**
- Version number 77
  - Virtual USB ports 44
  - VLAN (Virtual Local Area Network) 30
    - IPv4 client VLAN 30
    - IPv4 management VLAN 30
    - USB ports 30
- W**
- Warnings 6
  - Website 5
- Z**
- Zeroconf 21